

Surgical Technique

5.0mm Wise-Lock Femoral Neck Plate System

Intended Use, Indications and Contraindications, Adverse Events

Intended Use

The Femoral Neck System (FNS) is intended for temporary fixation, correction or stabilization of bones in the femoral neck.

Indications

- Femoral neck fractures (type 31-B)

Contraindications

- Pertrochanteric fractures (type 31-A1 and 31-A2)
Intertrochanteric fractures (type 31-A3)
- Subtrochanteric fractures

Additionally, this system should not be used for cases where there is a high incidence of:

- Sepsis
- Malignant primary or metastatic tumors
- Material sensitivity
- Compromised vascularity

Adverse Events

As with all major surgical procedures, risks, side effects and adverse events can occur. While many possible reactions may occur, some of the most common include: Problems resulting from anesthesia and patient positioning (e.g. nausea, vomiting, dental injuries, neurological impairments, etc.), thrombosis, embolism, infection, excessive bleeding, iatrogenic neural and vascular injury, damage to soft tissues incl. swelling, abnormal scar formation, functional impairment of the musculoskeletal system, Sudeck's disease, allergy/hypersensitivity reactions and side effects associated with hardware prominence, malunion, non-union, device breakage, device loosening. Additional device specific adverse events that may occur: Pain, device migration (e.g. wire migration and penetration into the pelvic cavities), bone damage and bone fracture.

Surgical Step Etchings

- The main instruments are etched with letters and arrows to facilitate the surgical procedure
- Corresponding letters are highlighted in this surgical technique

Protection Sleeve

- Used to insert Locking Screws
- Helps to protect soft tissue

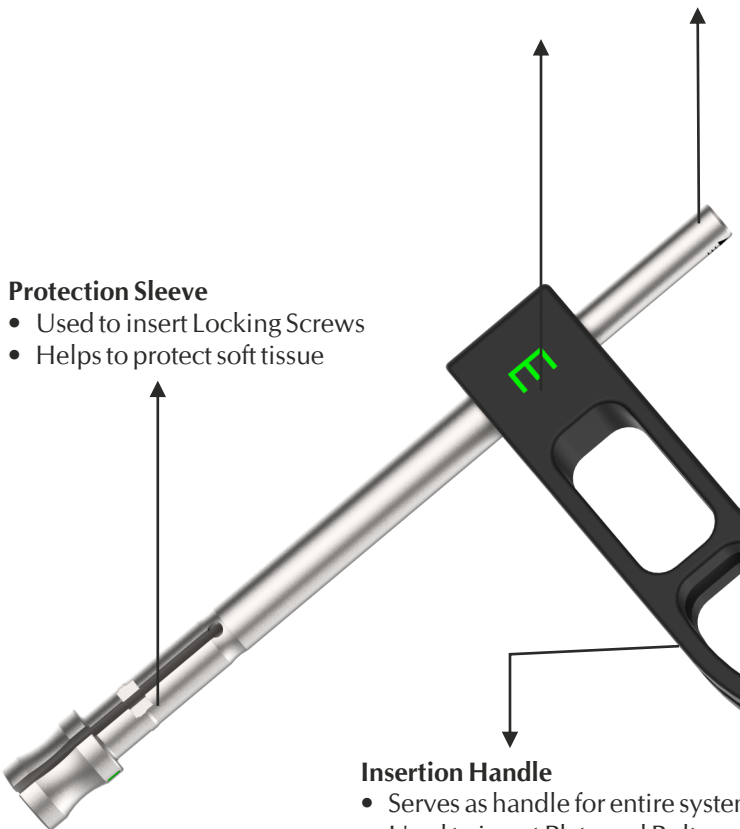

Insertion Handle

- Serves as handle for entire system
- Used to insert Plate and Bolt
- Allows to guide additional wires

Insert for Insertion Handle

- Serves as guide to insert the Antirotation-Screw
- Allows intra-operative compression (in combination with the Multifunction Rod)



Preparation

1. Position Patient

Place the patient in a supine position on the operating table.

- Position the image intensifier to enable visualization of the proximal femur in both the AP and lateral planes. (1)

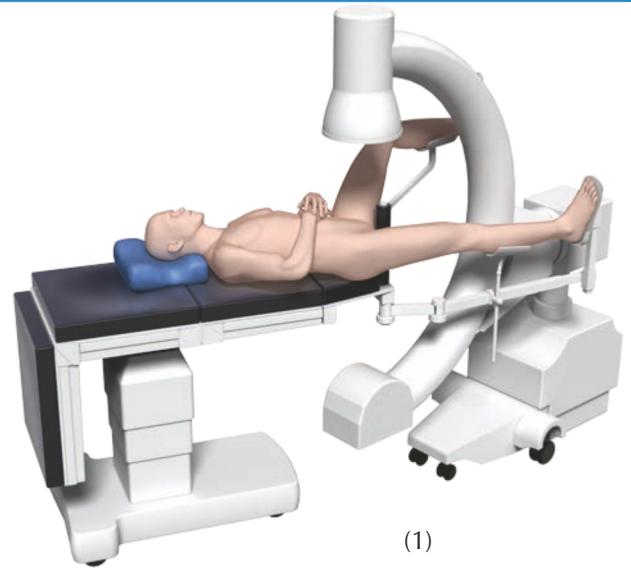

2. Reduce Fracture

Note: Proper reduction of the fracture is crucial for good bone healing and function as well as reduction of complications.

Reduce the fracture by means of gentle traction/flexion, adduction/abduction and internal rotation (about 15°, so the femoral neck is parallel to the operating table).

- Check the reduction in two planes under image intensifier control. If the reduction is insufficient consider open reduction.

Insert an unused wire as an antirotation wire in the superior/anterior part of the femoral neck to prevent any inadvertent rotation of the femoral head.

Notes:

- An inappropriate position of the antirotation wire may interfere with the proper placement of the implant.
- The antirotation wire can be placed percutaneous or through the lateral incision.

Precaution: Monitor the position of the wire during insertion and confirm the final position using the image intensifier. Over inserting guide wires could lead to damage to vital organs.

Before Reduction

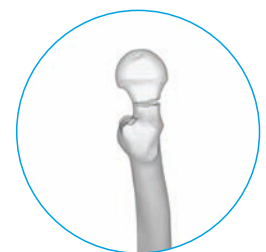

After Reduction

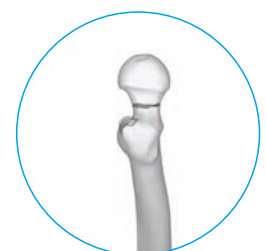

Temp. Fixation

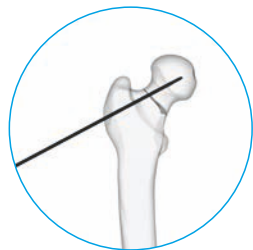

3. Approach

Make a straight lateral skin incision of approximately 6 cm in length, starting 2 to 3 cm proximal to the center of the femoral neck axis. (1)

Access and expose the lateral femoral surface accordingly for satisfactory hardware placement.

Option:

In obese patients, consider making a second incision during locking screw insertion. The second incision needs to be at the entry point of the protection sleeve, proximal to the main incision (see step Antirotation-Screw and Locking Screw Insertion for additional information on attaching the protection sleeve).

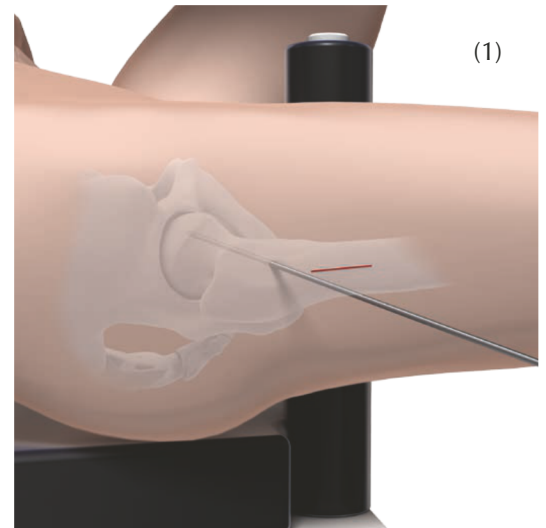

Implant Insertion

Irrigate and apply suction for removal of debris potentially generated during implant insertion.

1. Insert Guide Wire

Insert a second, unused guide wire as central guide wire, using the 130° angled guide. (1)

- Use image intensification to place the guide wire slightly inferior to the apex of the femoral head, extending into the subchondral bone on the AP view. (2)

In the lateral view, the guide wire should be central in the femoral neck and head. (3)

Note: The position of the guide wire within the femoral neck and head should be chosen according to the patient's anatomy before fracture. The implant plate allows a placement of about $\pm 5^\circ$ compared to the 130° angle.

Precautions:

- Monitor the position of the wire during insertion and confirm the final position using the image intensifier. Over inserting guide wires could lead to damage to vital organs.
- Replace wires if they are bent after insertion.

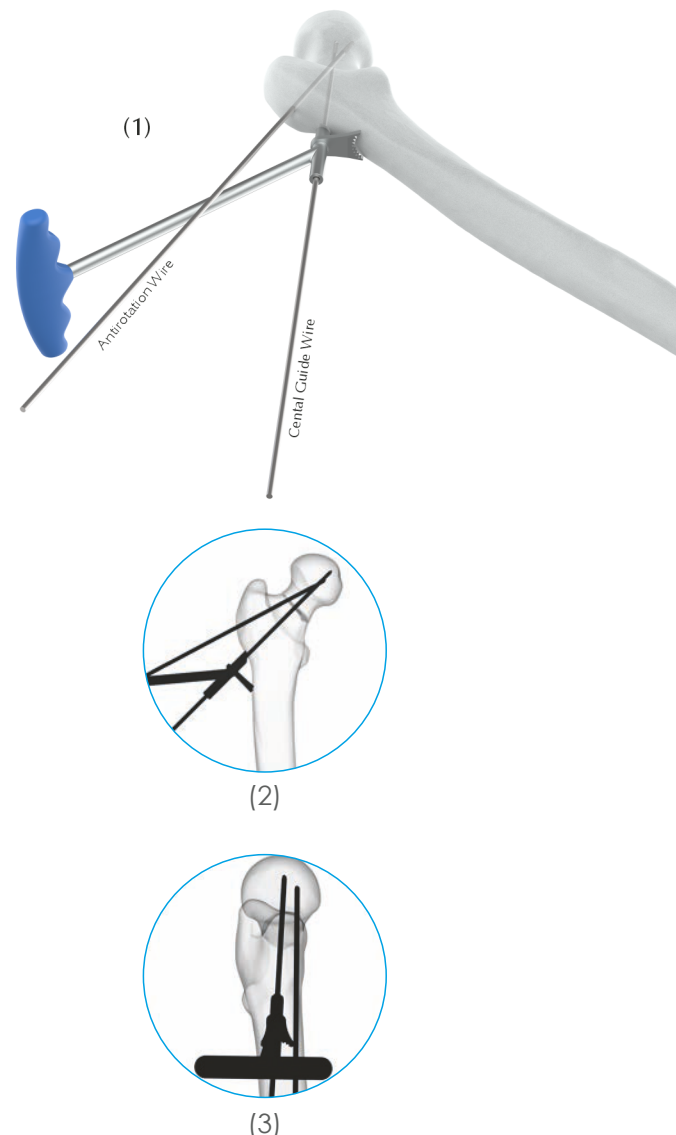

2. Option: Adjust Guide Wire

Use the correction guide and an unused guide wire to adjust the position of the central guide wire in reference to the initial central guide wire. The following three types of adjustments are possible:

1. Parallel Correction (5 mm)

Insert the correction guide over the initial wire (Orange) and turn the correction guide to define the new entry point (anterior/posterior or inferior/superior). Then use a new wire in the parallel hole (green) and remove the initial wire.

1. Example:

Parallel correction with new entry point anterior.

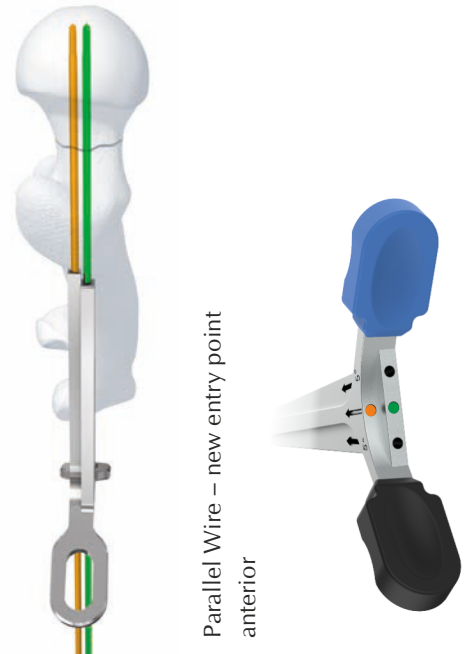

2. Angle Correction (5°) and Entry Point Correction (5 mm)

Insert the correction guide over the initial wire (orange) and turn the correction guide to define the new entry point. Then use a new wire in either the left or the right 5°-hole (green).

2. Example:

Angle correction towards anterior with new entry point superior.

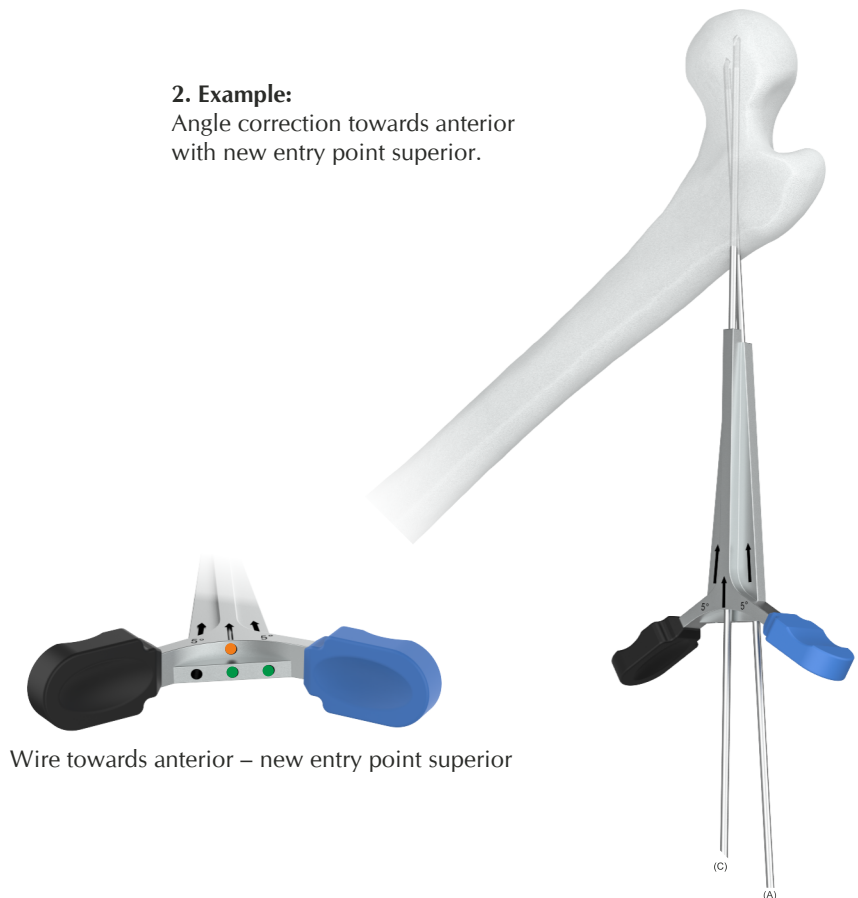

3. Angle Correction (5°) and Same Entry Point

Insert the correction guide over the initial wire (orange) hole in side-view, turn the correction guide to choose the new temporary entry point, insert a new wire in the parallel hole (blue) and remove the initial wire. Then use a new wire in either the left or the right 5°-hole (green) to correct the angle.

Precautions:

- Monitor the position of the wire during insertion and confirm the final position using the image intensifier. Over inserting guide wires could lead to damage to vital organs.
- Replace wires if they are bent after insertion.

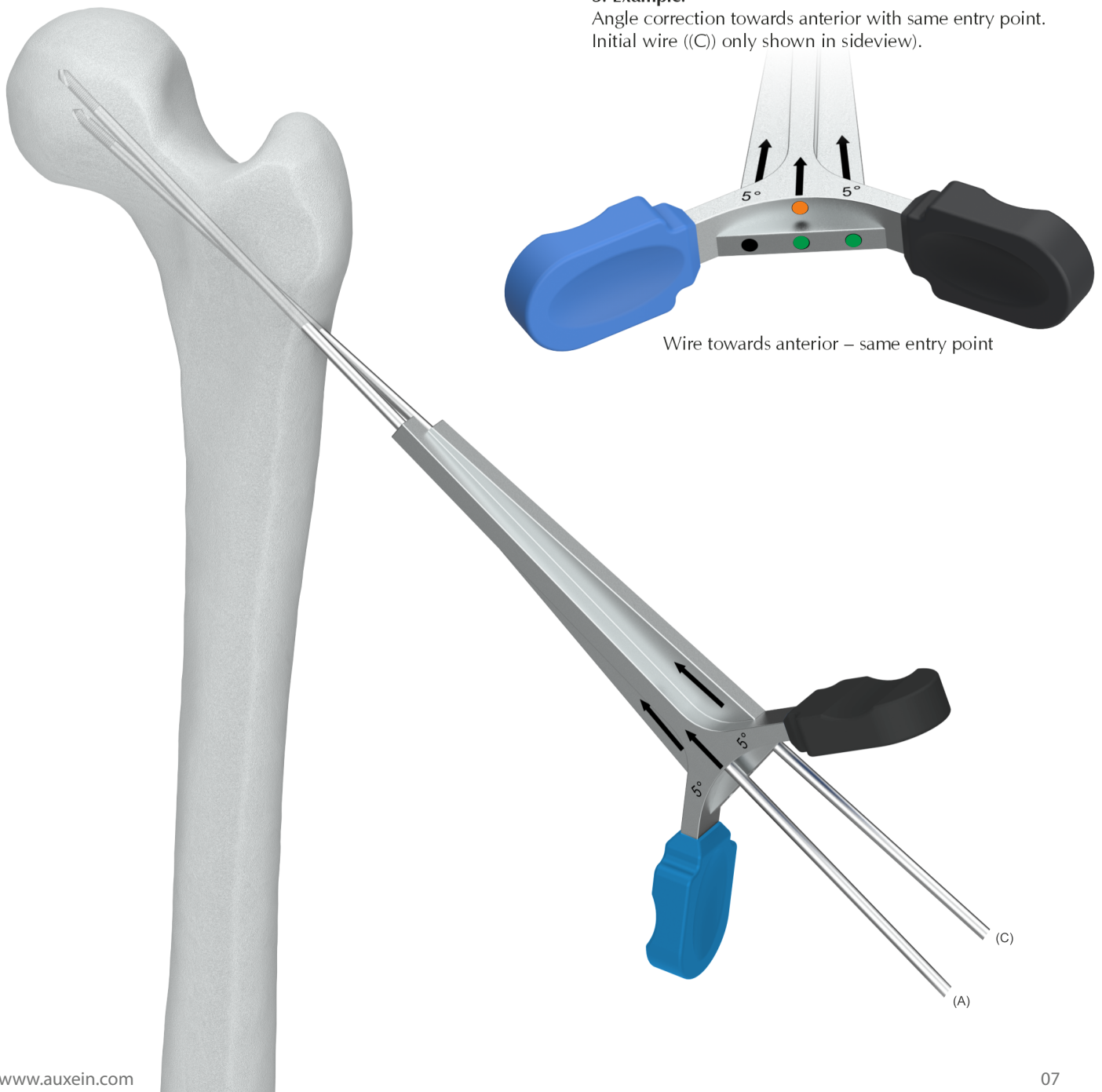

3. Determine Length

Slide the direct measuring device over the central guide wire. (1)

Read the depth of the guide wire on the direct measuring device. (2)

As the guide wire is inserted into the subchondral bone (in the AP view), remove 5 mm from the value seen on the direct measuring device and choose the next shorter construct size.

The available construct sizes are:

75 mm	95 mm	115 mm
80 mm	100 mm	120 mm
85 mm	105 mm	125 mm
90 mm	110 mm	130 mm

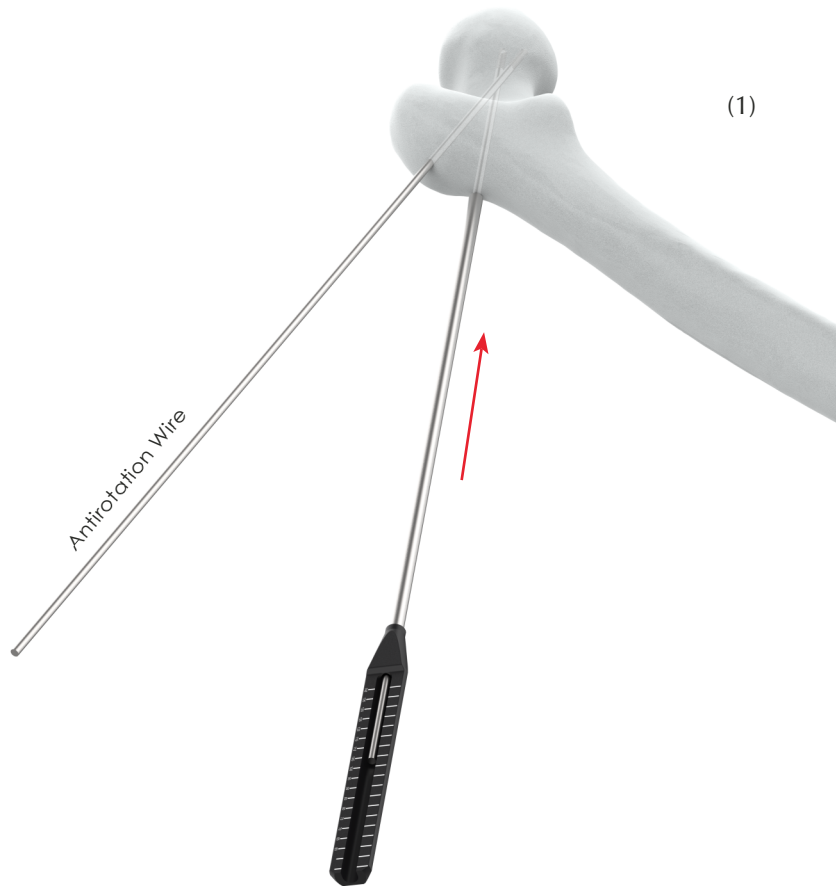

Example: If you read 102 mm on the direct measuring device, the construct size of the implant should be 95 mm ($102 - 5 = 97$ choose 95 mm).

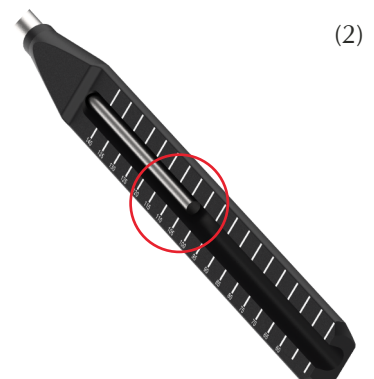

4. Ream for Insertion of Plate and Bolt

Assemble the reamer by sliding the reamer-component over the drill bit until it clicks into place at the selected construct size (95 mm in the example before). Secure the reamer by tightening the nut. (1)

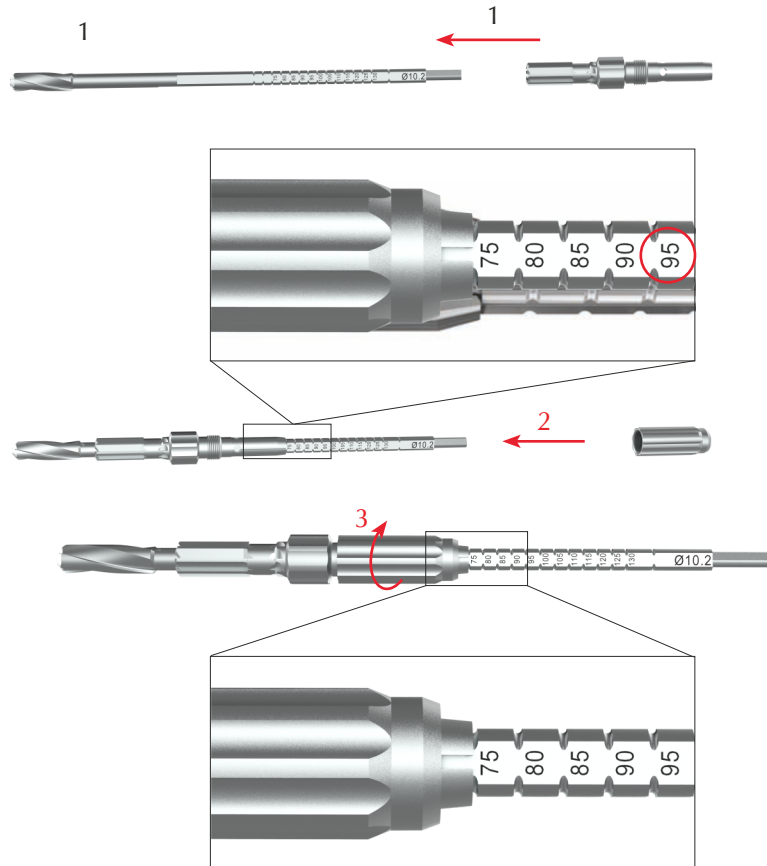

Ream down until the reamer stops on the bone. (2)

Notes:

- It is recommended that the femoral head is temporarily fixated with an antirotation wire prior to reaming.
- Control guide wire migration and check reaming depth during reaming using the image intensifier.
- When reaming in dense bone, use of continuous irrigation is recommended.
- Avoid excessive reaming force during reaming.

Remove the reamer.

It is important to reinsert the guide wire if it is removed accidentally. To reinsert the wire push the reamer back into the reamed hole (without the use of a power tool) and use the cannulation to reinsert the guide wire into the original position.



5. Assemble Implant and Insertion Instruments

A Slide the insert into the insertion handle, without tightening the black screw. (1)

Fully insert the bolt with the selected construct size (95 mm in the example before) into the plate. (2)

B Mount the implant onto the insertion handle. (3)

Note: Ensure that the implant is correctly fixed to the insertion instrument and that the bolt is in the completely extended position.

C Manually tighten the black screw of the insert to attach the implant. (4)

Precaution: Hand-tightening the black screw is sufficient. Using additional tools might cause overtightening.

Option: A longer side plate with two locking holes (2-hole plate) is available as option.

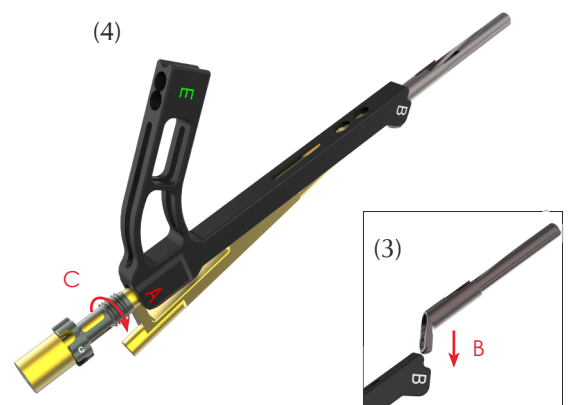
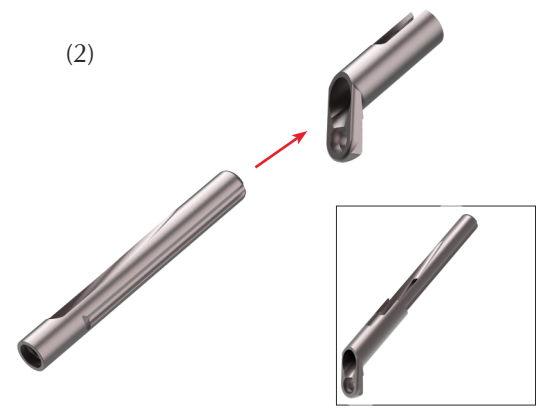
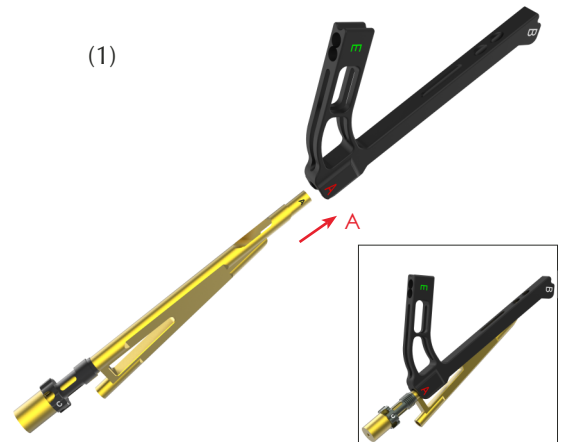

6. Insert Implant

6. Insert Implant

Insert the implant over the central guide wire into the pre-reamed hole. (1)

Precaution: When not using the cylinder, the guide wire will become visible on the outer side of the insert. Ensure not to move the guide wire. (2)

Option:

The cylinder can be used to manually tap the plate onto the bone. (3) If additional tapping is required, use a standard surgical hammer to slightly tap onto the cylinder.

- Use image intensification to confirm the insertion depth and ensure that the plate is inserted down to the bone as well as aligned with the axis of the femoral shaft. (4)

Notes:

- It is recommended that the femoral head is temporarily fixated with an antirotation wire prior to implant insertion.
- Avoid excessive insertion force.
- After insertion, ensure that the instruments are still correctly fixed to the implant.



(4)



(4)

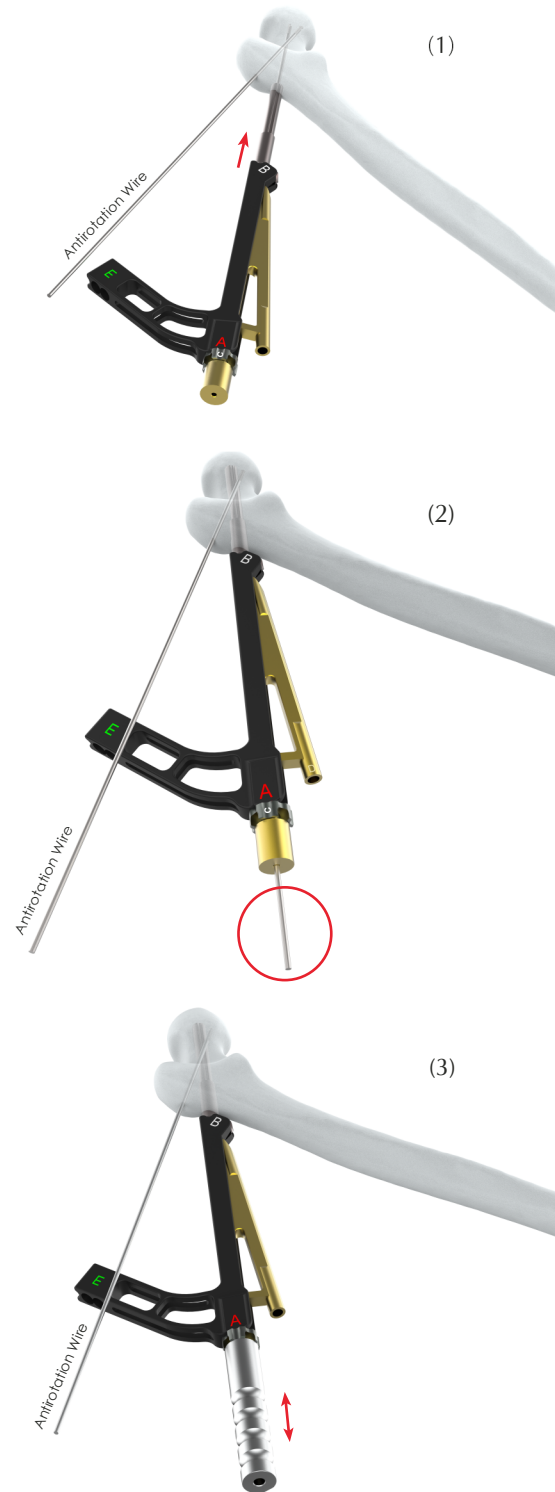

7. Remove Guide Wire

Remove the central guide wire. (1)

Keep the antirotation wire to prevent loss of reduction and rotation of the head.

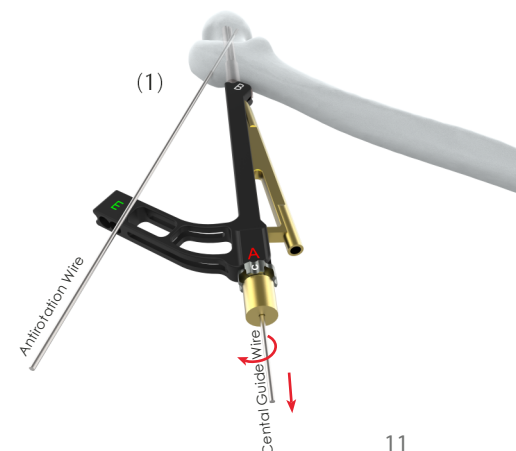

Antirotation-Screw and Locking Screw Insertion

Irrigate and apply suction for removal of debris potentially generated during antirotation-screw and locking screw insertion.

1. Drill for Antirotation-Screw

Pass the fixation sleeve over the back end of the drill bit and check the fixation sleeve for wear per the instructions on page 32. (1) Adjust the setting to the chosen construct size (95 mm in the example). (2)

Notes:

- The length of the bolt and the antirotation-screw are pre-defined based on the selected construct size.
- Ensure that the central guide wire is removed before drilling.
- Confirm that the insertion handle and plate are aligned with the femoral shaft before drilling for the antirotation-screw. (3)

Use the guide of the insert to drill the hole for the antirotation-screw. (4)

Drill until the fixation sleeve stops on the guide of the insert. (5)

Precaution: Monitor depth during drilling using the image intensifier. Drilling too deep could lead to bone damage.

Remove the drill bit.

(1)



(2)

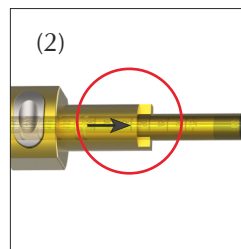

(3)



(4)

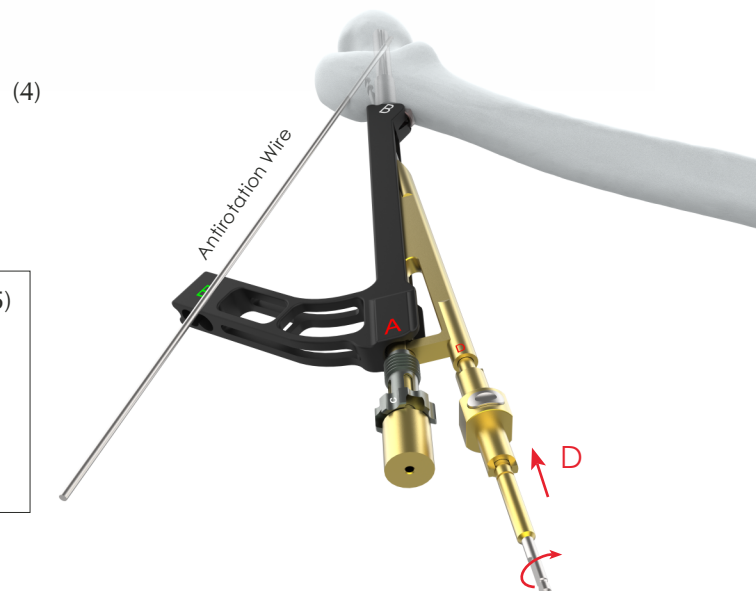

(5)

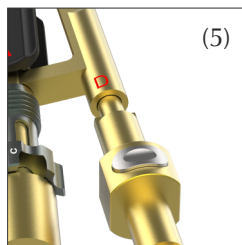

2. Insert Antirotation-Screw

Note: Confirm that the insertion handle and plate are aligned with the femoral shaft.

D Insert the antirotation-screw with the selected construct size (95 mm in the example). (1)

Insertion as well as final tightening should be done slowly and by hand using the screwdriver shaft, together with the 4 Nm Torque Limiter and the appropriate handle. (2) If dense bone is preventing antirotationscrew insertion, then carefully use the handle without Torque Limiter for insertion.

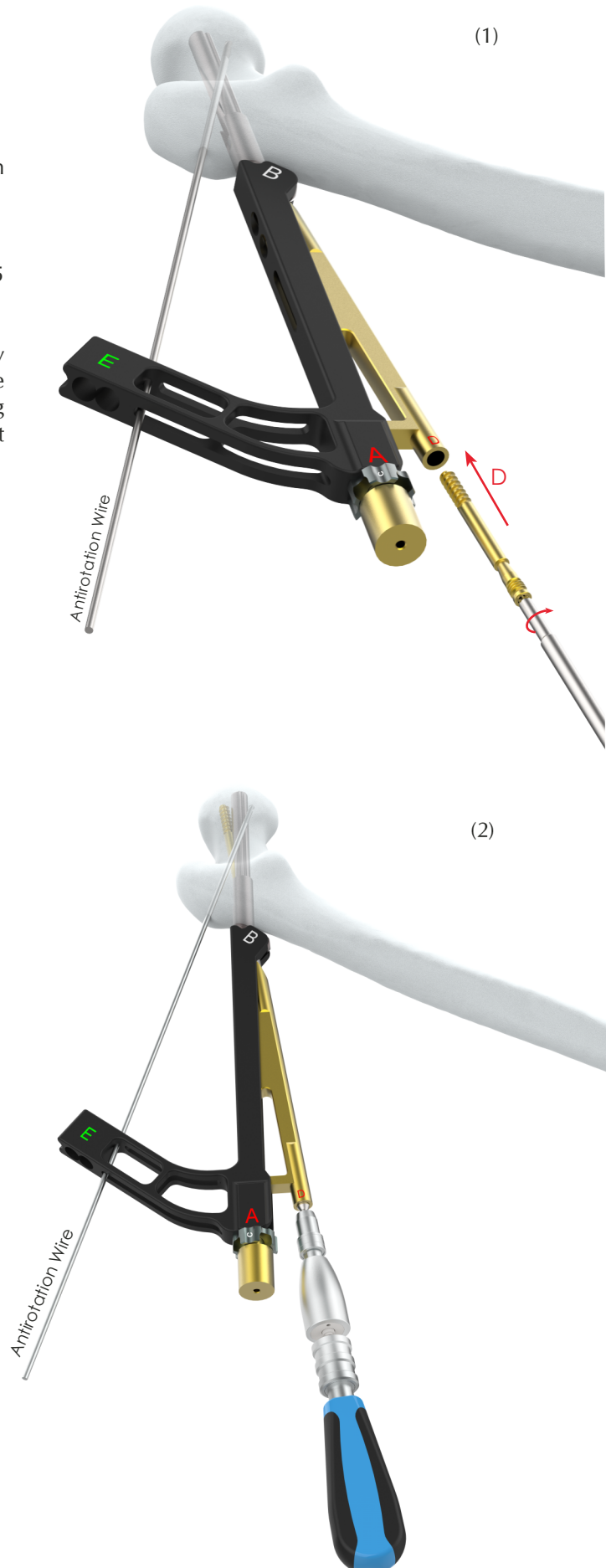

Precautions:

- Monitor antirotation-screw insertion and confirm screw position using the image intensifier prior to final tightening.
- Confirm that the femoral head is temporarily fixated with an antirotation wire and hold the position of the handle during final tightening to prevent any inadvertent rotation.
- After final tightening, use the image intensifier to check that the antirotation-screw is fully inserted. (3) If not, then loosen and reinsert the antirotation-screw. Use the 4Nm torque limiter and the appropriate handle for final tightening.

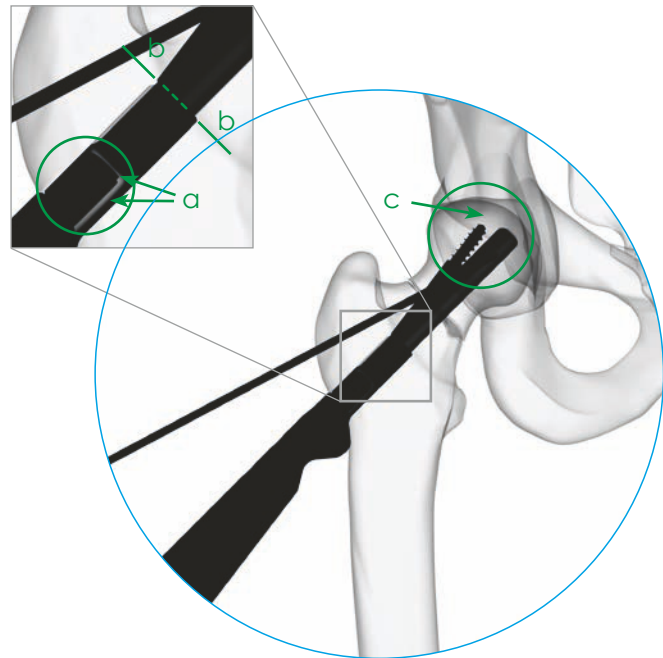

(3)

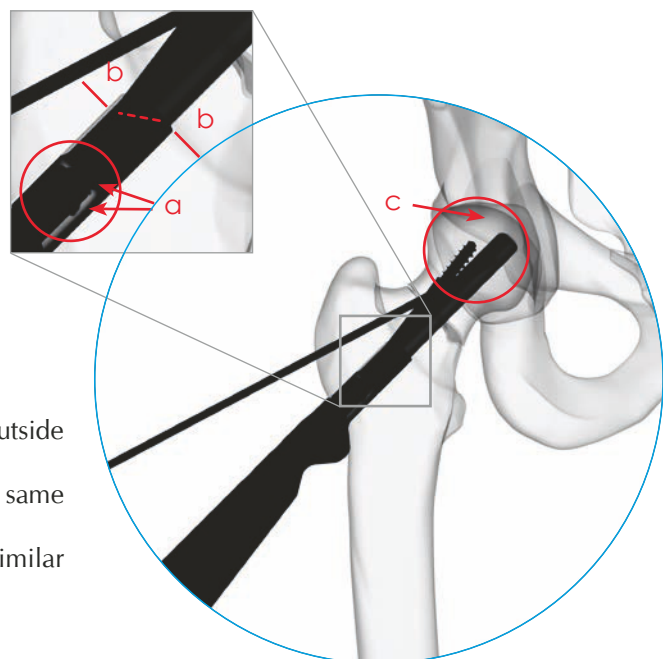

(3)

- a The head of the antirotation-screw should not appear outside of the bolt.
- b The notch of the antirotation-screw should be at the same level as the notch of the plate.
- c The tip of the antirotation-screw should be in a similar insertion depth when compared to the tip of the bolt.

(1)

3. Attach Protection Sleeve for Locking Screw Insertion

Remove any antirotation wires.

E Attach the protection sleeve to the insertion handle. (1)

Notes:

- In obese patients, the use of a second incision to insert the protection sleeve should be considered.
- Check that the protection sleeve is inserted in the correct position (1-hole plate or 2-hole plate) of the insertion handle.
- Insert the proximal locking screw first if using a 2-hole plate.

Check that the protection sleeve is fully inserted. (2)

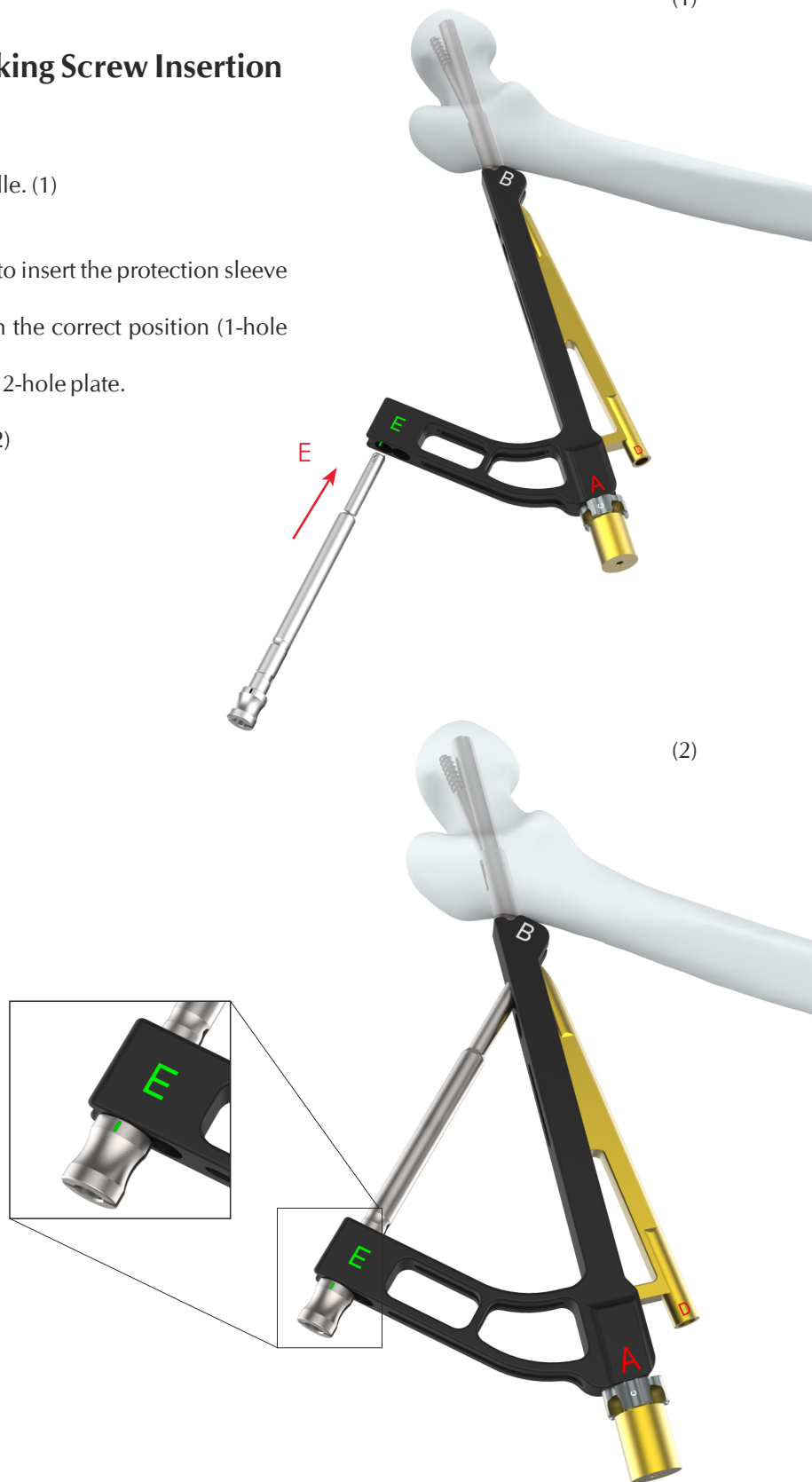

4. Drill for Locking Screw

Check that the fixation sleeve is removed from the drill bit.

Note: Confirm that the insertion handle and plate are still aligned with the femoral shaft.

F Drill the hole for the bi-cortical locking screw through the protection sleeve. (1)

Read the screw length directly off the etching on the drill bit. (2)

Option: Use the depth gauge through the protection sleeve to determine the depth of the drilled hole. The screw length should be chosen at least 4 mm longer than the determined depth of the hole. (3)

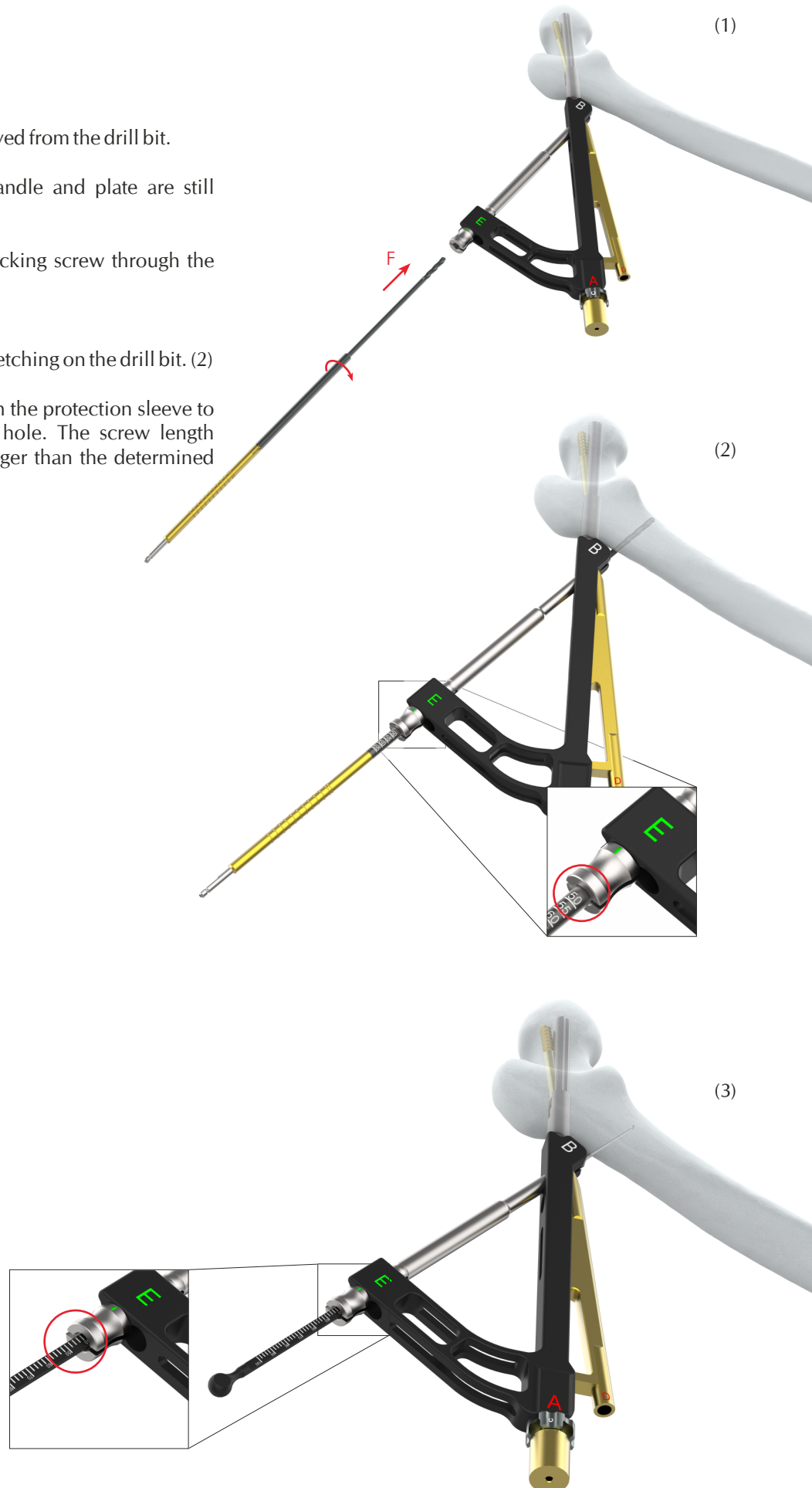

5. Insert Locking Screw

Note: Confirm that the insertion handle and plate are still aligned with the femoral shaft.

F Insert the locking screw with the determined length, as read from the drill bit or depth gauge. (1)

The locking screw may be inserted using power equipment. Final tightening must be done slowly and by hand using the screwdriver shaft, together with the 4 Nm Torque Limiter and the appropriate handle. (2)

Note: Monitor locking screw insertion and confirm screw position as well as length using the image intensifier prior to final tightening.

Option: If using a 2-hole plate, repeat steps 3 to 5 to insert the distal screw. (3)

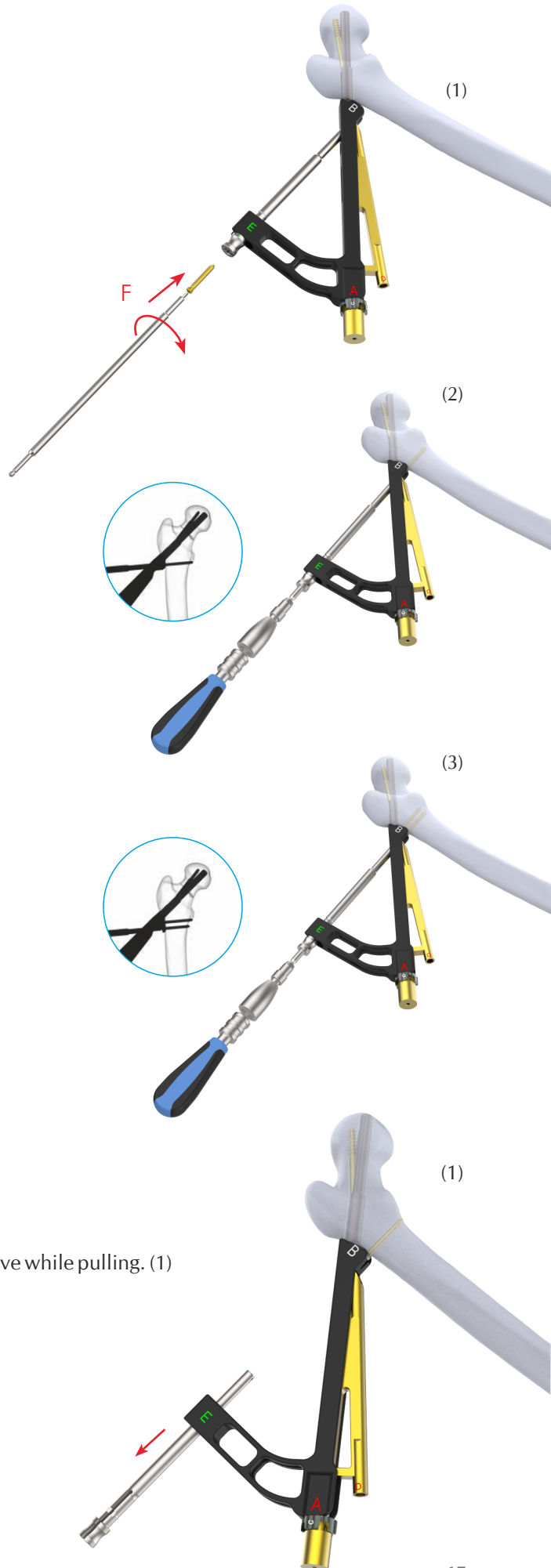

6. Remove Protection Sleeve

Remove the protection sleeve by pressing together the head of the sleeve while pulling. (1)

Option: Intra-Operative Compression

Inter-fragmentary compression may be applied intra-operatively. The locking screw as well as the antirotationscrew need to be inserted prior to applying compression.

1. Attach Multifunction Rod for Compression

Insert the multifunction rod through the guide of the antirotation-screw. (1)

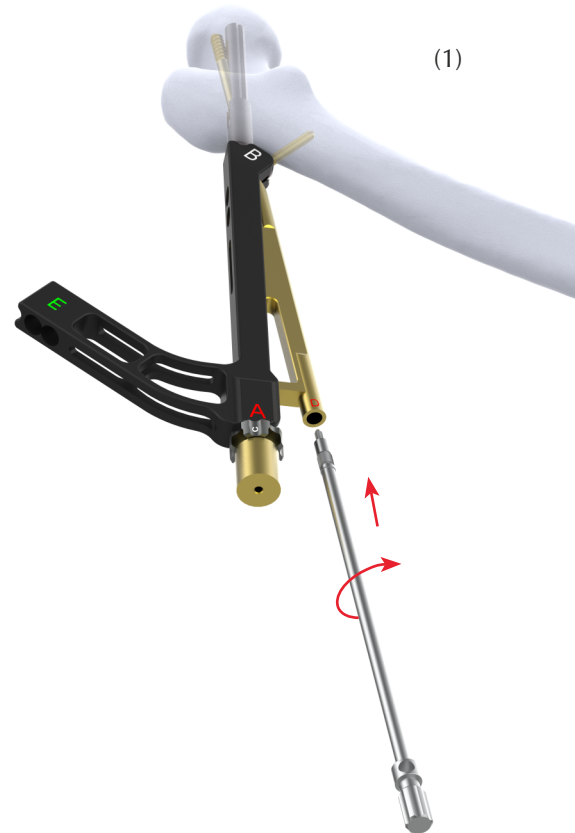

Hand-tighten the rod by turning it clockwise until the rod is fully inserted. (2)



2. Appl Compression

Note:

- If applicable, consider to loosen traction before applying compression.
- Monitor the implant position during compression using the image intensifier.

Apply inter-fragmentary compression by turning the screw of the insert counter-clockwise. (1)

Precaution: Applying compression by hand is sufficient. Using additional tools for compression might cause excessive forces.

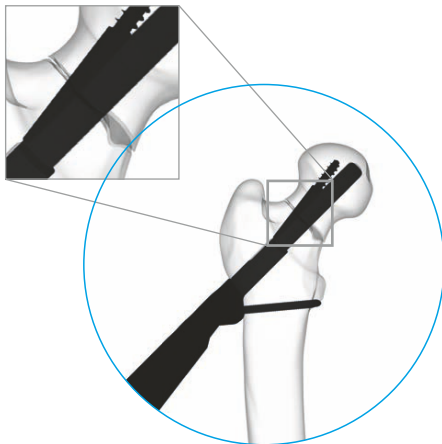

Before Compression

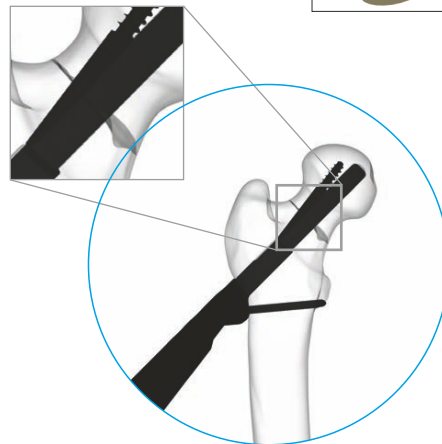

After Compression

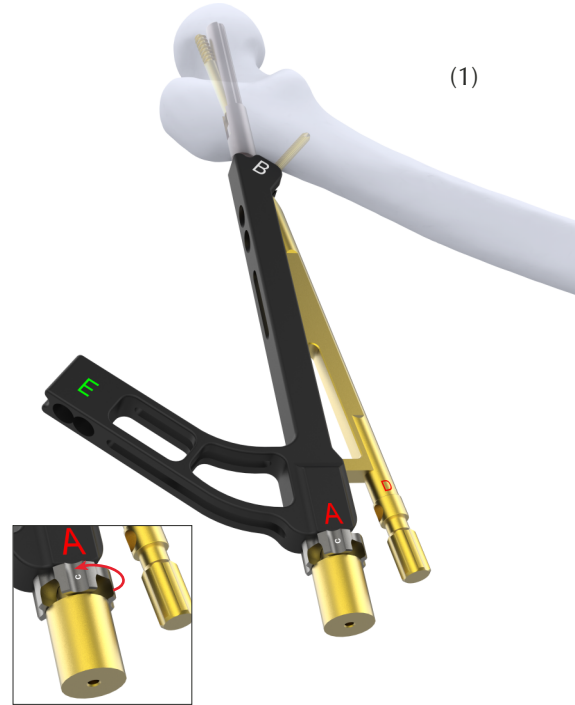

3. Remove Multifunction Rod

Remove the multifunction rod by turning it counterclockwise. (1)

Note: If loosening by hand is not possible, then use another instrument (e.g. a screwdriver shaft) through the hole in the multifunction rod to untighten it.

- Use image intensification to confirm that the antirotation-screw remains locked in the implant.

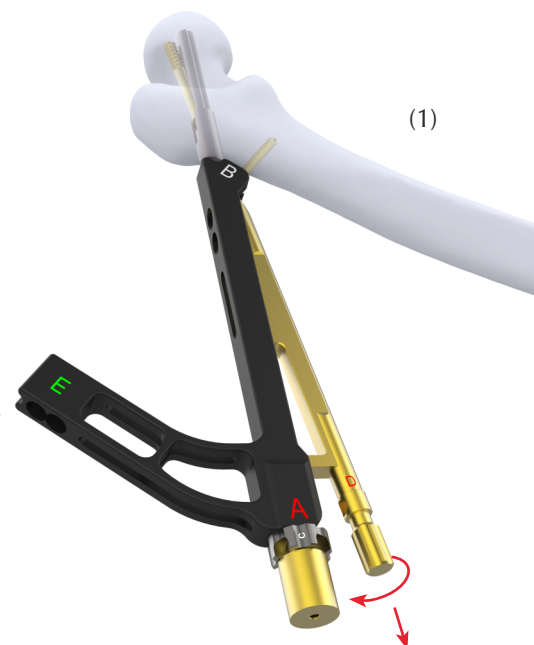

Instrument Disassembly and Final Check

1. Remove Insertion Instruments

Unscrew (counter-clockwise) the insert from the insertion handle by completely loosening the screw of the insert. (1)

Remove the insert from the insertion handle. (2)

Remove the insertion handle by sliding it off the plate in a distal direction. (3)

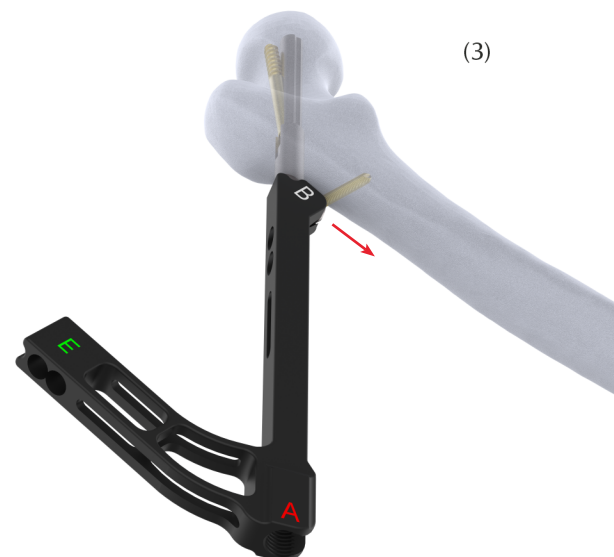
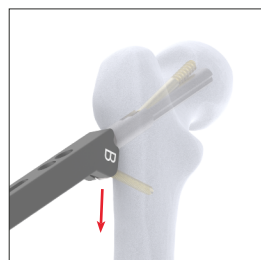
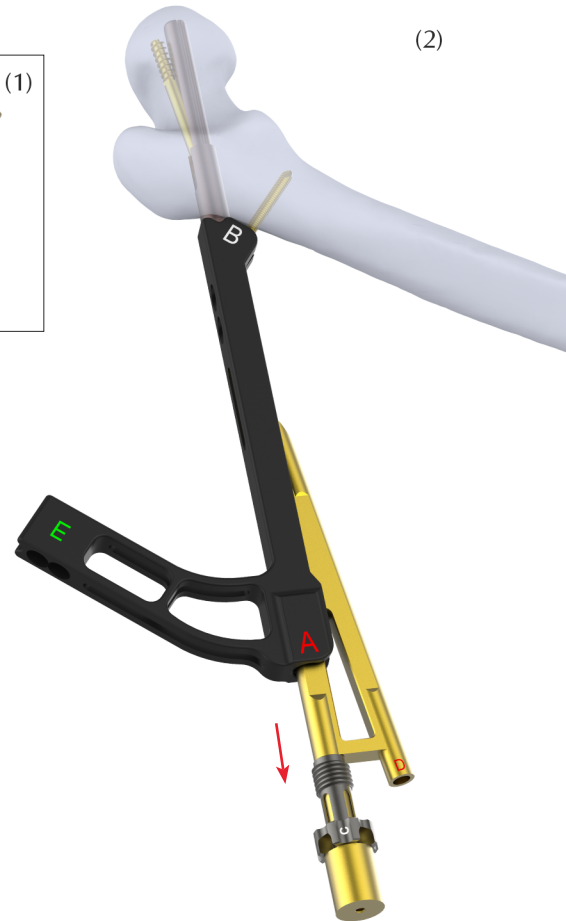
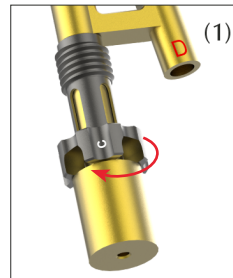

2. Final Check

Before closing the wound, confirm the implant size and positioning under image intensifier control. (1)



Option: Implant Removal

Irrigate and apply suction for removal of debris potentially generated during implant removal.

1. Remove Locking Screw(s)

Remove the locking screw(s) by hand using the screwdriver shaft together with the appropriate handle and without torque limiter. (1)

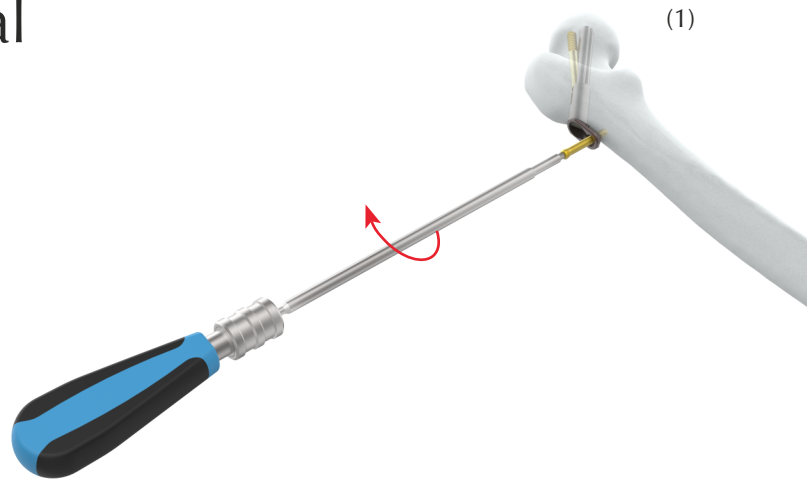

Note: If the implant is fully telescoped, resulting in the bolt being more lateral than the plate (2), pull on the plate (e.g. with surgical pliers) to extend it from the bolt (to about 5 mm) before conducting the steps on the following pages. (3)

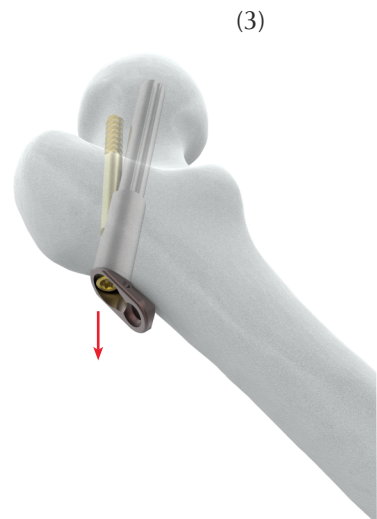
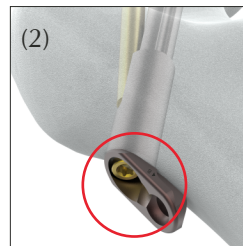

2. Remove Antirotation-Screw

Remove the antirotation-screw by hand using the screwdriver shaft together with the appropriate handle and without torque limiter. (1)

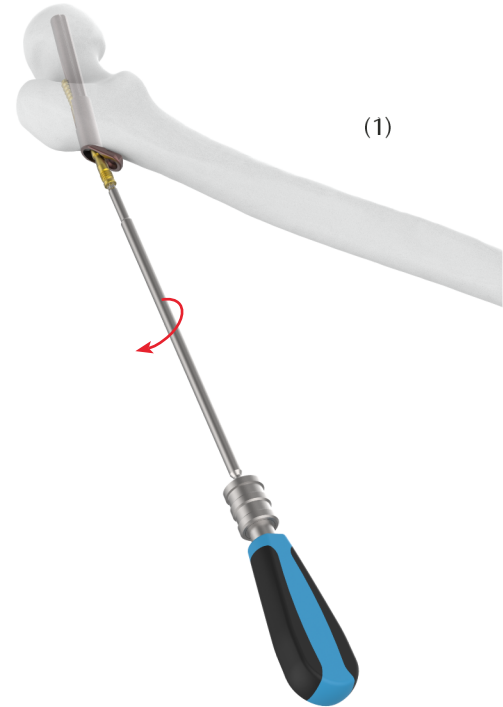

Options:

- If it is difficult to find the recess of the antirotation screw, then use the Insert (7-131-08) as a guide within the plate. (2)

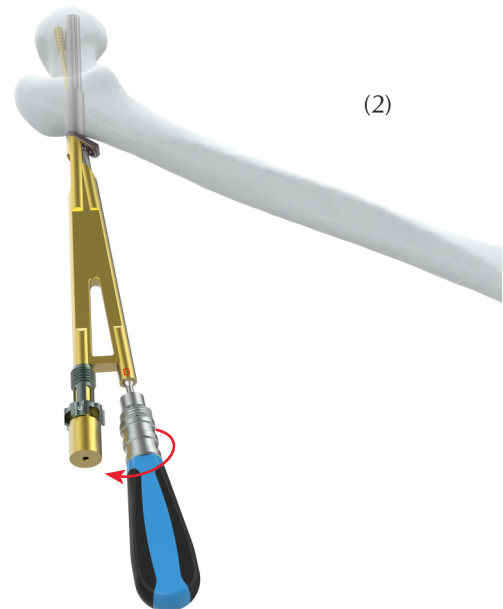

- If the antirotation-screw gets detached from the screwdriver, then use the multifunction rod and turn it clockwise to catch the antirotation-screw. Pull on the multifunction rod and turn anti-clockwise to fully remove the antirotation-screw. (3)

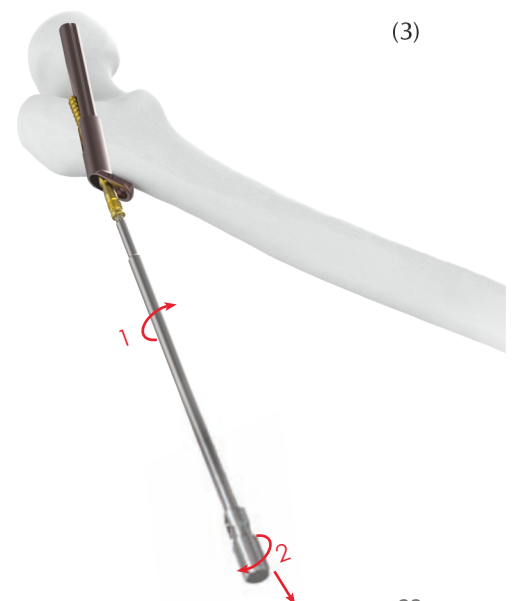
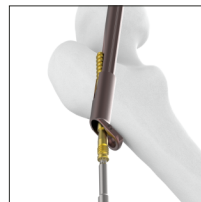

3. Remove Plate and Bolt

Slide the cylinder over the multifunction rod. (1)

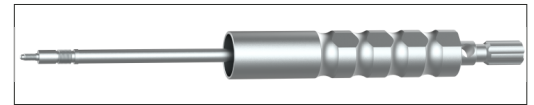
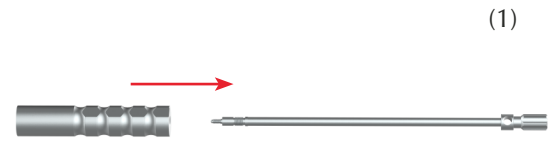

Attach the multifunction rod by turning it clockwise. Use the direction of the previously removed antirotationscrew. (2)



Tap outward with the cylinder to remove the plate and bolt simultaneously. (3)

Note: Avoid excessive forces during removal.



Checking Fixation Sleeve Wear

1. Perform Fixation Sleeve Wear Test

If excessive wear occurs, the fixation sleeve can slip, resulting in incorrect drilling depth.

Before use:

- Slide fixation sleeve onto the drill bit
- Press on the fixation sleeve with the thumb without pressing the button. If the fixation sleeve moves under pressure, replace it
- Do the same test in the opposite direction. If the fixation sleeve moves, replace it

Precautions:

- Drill only under periodic image intensifier control.
- While drilling, do not force.
- Replace fixation sleeves that do not pass the described wear test.

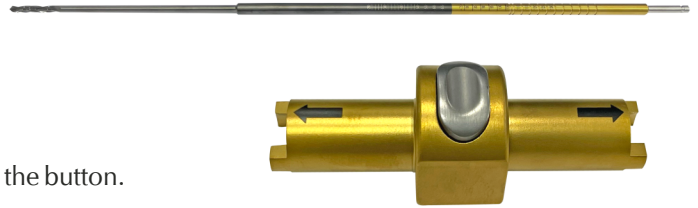

SYSTEM HIGHLIGHTS

The Femoral Neck System (FNS) is a dedicated product for the fixation of femoral neck fractures and offers the following features:

Antirotation-Screw

- Material: GR-5 (Ti-6AL-4V)
- Color: Golden
- Diameter: 6.4 mm
- Recess: Stardrive T25
- Construct Lengths: 75 to 130 mm (5 mm increments)
- Sterile/Non-Sterile

Sterile Packaging

- Implant Kit packaging
- Plate, Bolt and Antirotation-Screw packaged in one kit
- Reduced storage space
- Reduced packaging waste
- Also available in single packaging

Plate

- 130° Femoral Neck Plate angle
- Material: GR-5 (Ti-6AL-4V)
- Color: TYPE-II
- Lengths: 1-hole and 2-hole
- Sterile

Locking Screw

- Material: GR-5 (Ti-6AL-4V)
- Color: Golden
- Diameter: 5.0 mm
- Recess: Hexagonal
- Lengths: 30 to 60 mm – suggested range, other lengths available (30 to 50 mm with 2 mm increments, 50 to 60 mm with 5 mm increments)
- Non-Sterile

Bolt

- Material: GR-5 (Ti-6AL-4V)
- Color: TYPE-II
- Diameter: 10 mm
- Construct Lengths: 75 to 130 mm (5 mm increments)
- Sterile

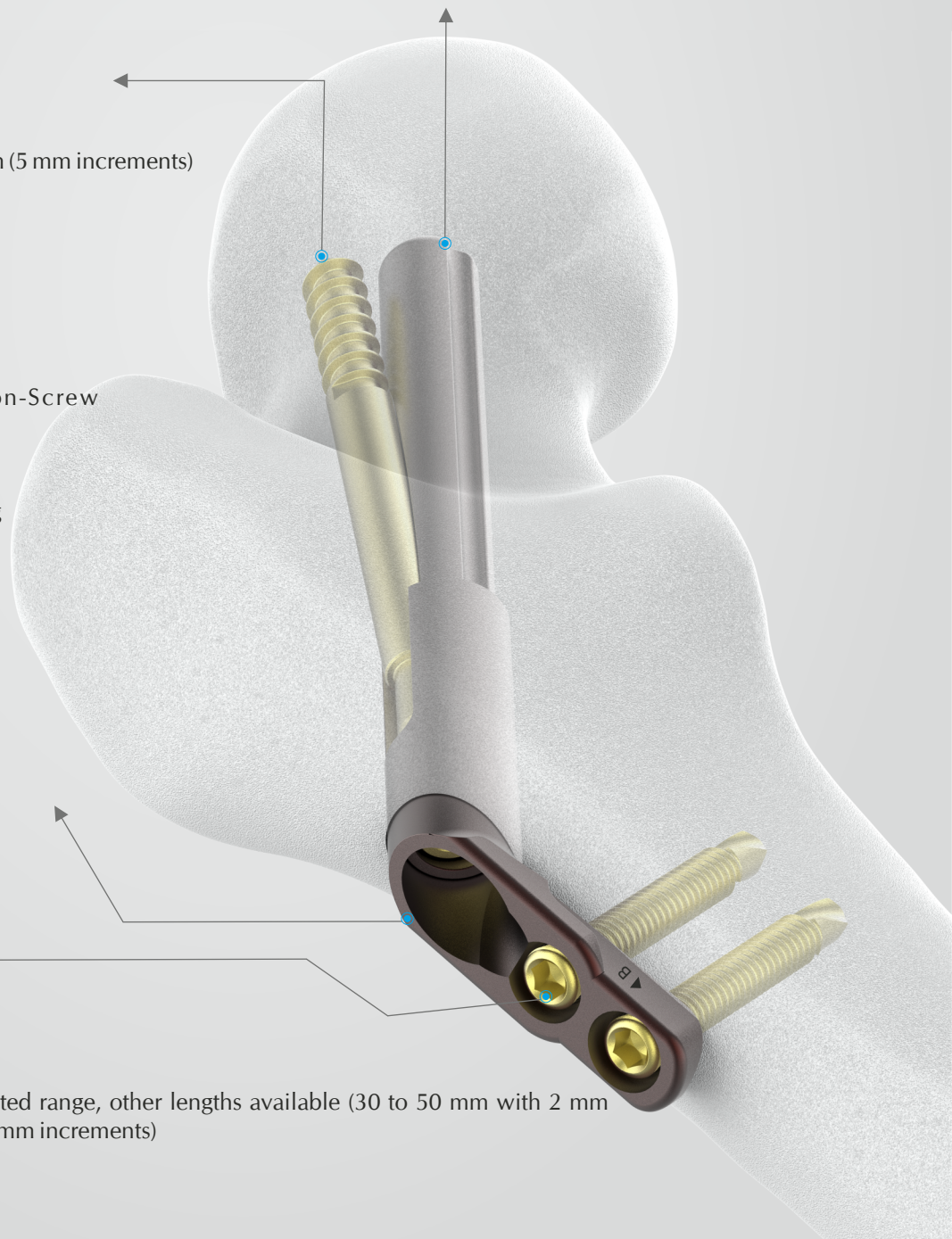

5.0mm Wise-Lock Femoral Neck Plate

Holes	Titanium
1	10-053-01TI
2	10-053-02TI

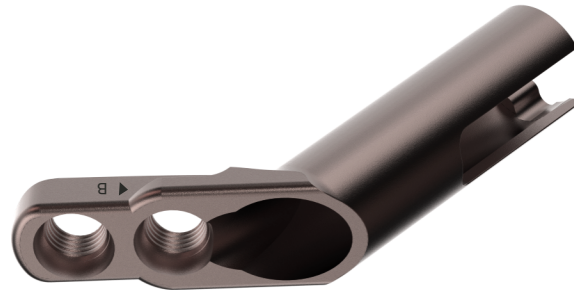

10.0mm Bolt for Femoral Neck Plate

Ø Dia	Length (mm)	Titanium
10.0mm	75mm	10-054-075TI
10.0mm	80mm	10-054-080TI
10.0mm	85mm	10-054-085TI
10.0mm	90mm	10-054-090TI
10.0mm	95mm	10-054-095TI
10.0mm	100mm	10-054-100TI
10.0mm	105mm	10-054-105TI
10.0mm	110mm	10-054-110TI
10.0mm	115mm	10-054-115TI
10.0mm	120mm	10-054-120TI
10.0mm	125mm	10-054-125TI
10.0mm	130mm	10-054-130TI



6.4mm Anti-Rotation Screw for Femoral Neck Plate



Ø Dia	Length (mm)	Titanium
Ø6.4mm	75mm	10-055-075TI
Ø6.4mm	80mm	10-055-080TI
Ø6.4mm	85mm	10-055-085TI
Ø6.4mm	90mm	10-055-090TI
Ø6.4mm	95mm	10-055-095TI
Ø6.4mm	100mm	10-055-100TI
Ø6.4mm	105mm	10-055-105TI
Ø6.4mm	110mm	10-055-110TI
Ø6.4mm	115mm	10-055-115TI
Ø6.4mm	120mm	10-055-120TI
Ø6.4mm	125mm	10-055-125TI
Ø6.4mm	130mm	10-055-130TI

5.0mm Wise-Lock Screw, Self-Tapping, (Hex Head)



Ø Dia	Length (mm)	Titanium
5.0mm	20mm	TI-119.020
5.0mm	22mm	TI-119.022
5.0mm	24mm	TI-119.024
5.0mm	26mm	TI-119.026
5.0mm	28mm	TI-119.028
5.0mm	30mm	TI-119.030
5.0mm	32mm	TI-119.032
5.0mm	34mm	TI-119.034
5.0mm	36mm	TI-119.036
5.0mm	38mm	TI-119.038
5.0mm	40mm	TI-119.040
5.0mm	42mm	TI-119.042
5.0mm	44mm	TI-119.044
5.0mm	46mm	TI-119.046
5.0mm	48mm	TI-119.048
5.0mm	50mm	TI-119.050
5.0mm	52mm	TI-119.052
5.0mm	54mm	TI-119.054
5.0mm	56mm	TI-119.056
5.0mm	58mm	TI-119.058
5.0mm	60mm	TI-119.060

7-131-22 Implant Tray for 5.0mm Wise-Lock Femoral Neck Plate System

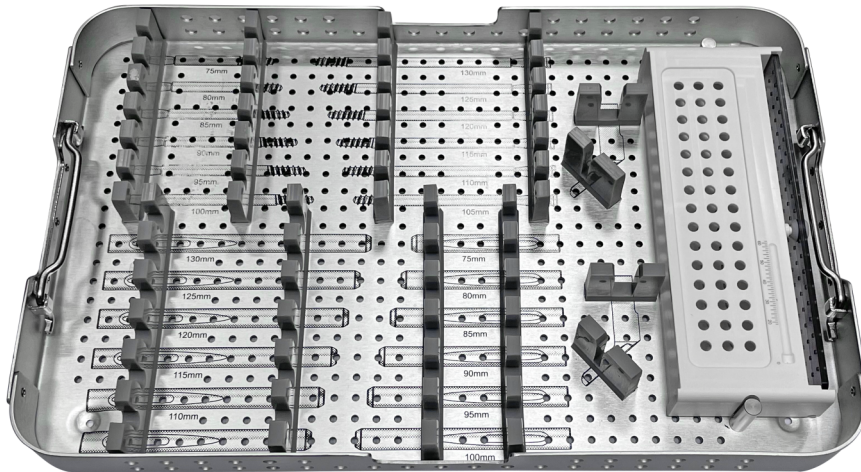

5.0mm Wise-Lock Femoral Neck Plate

Holes	Titanium	Qty
1	10-053-01TI	1Pcs
2	10-053-02TI	1Pcs

10.0mm Bolt for Femoral Neck Plate

Dia	Length	Qty
10.0mm	75mm to 130mm	1pcs

6.4mm Anti-Rotation Screw for Femoral Neck Plate

Dia	Length	Qty
6.4mm	75mm to 130mm	1pcs

5.0mm Wise-Lock Screw, Self-Tapping, (Hex Head)

Dia	Length	Qty
5.0mm	20mm to 60mm	2pcs

7-131-01 130° Angled Guide for FNP System



7-131-02 Correction Guide for FNP System

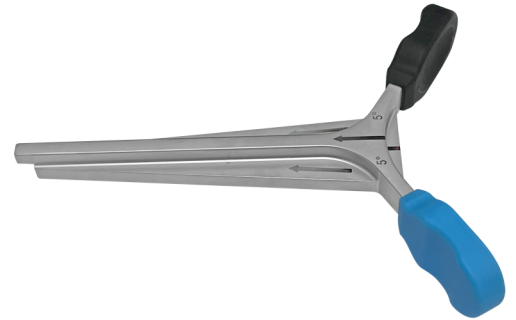

7-131-03 Guide Wire with Threaded Tip Ø3.2mm x Thread Length 14mm x Length 400mm

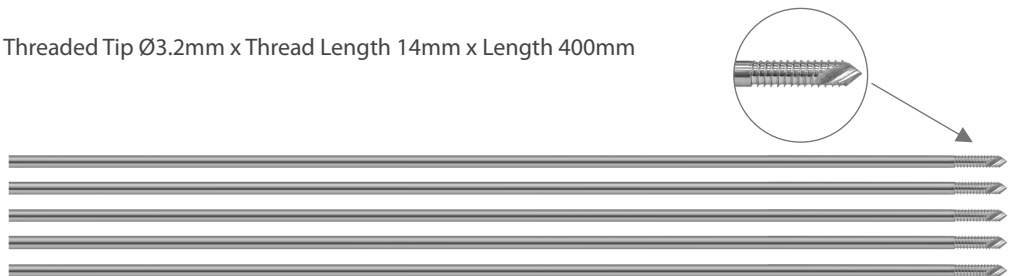

7-131-04 Guide Wire with One Side Trocar Tip Ø3.2mm x Length 400mm

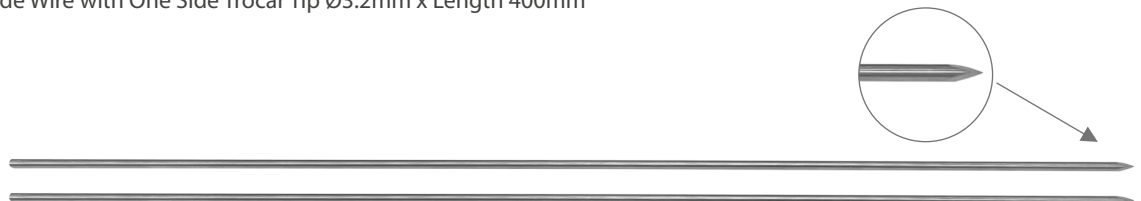

7-131-05 Direct Measuring Device for FNP System



7-131-06 Reamer, Complete



7-131-07 Insertion Handle for FNP System



7-131-08 Inserter for FNP System



7-131-09 Multifunctional Rod for Insertion Instruments - FNP System



7-131-10 Drill Bit Ø4.3mm x Length 413mm, for FNP System



7-131-11 Stopper for Drill Bit Ø4.3mm, for FNP System



7-131-12 Protection Sleeve for Insertion Instruments - FNP System



7-131-13 Screwdriver Shaft, T25 for FNP System



7-131-14 Cylinder for Insertion Instruments - FNP System



7-131-15 Screwdriver Shaft, Hex 3.5mm, for FNP System



7-131-16 Depth Gauge measuring upto 100mm for FNP System



7-131-17 Large Handle with Quick Coupling for FNP System



7-131-18 Torque Limiting Attachment, 4.0Nm, for FNP System



7-131-19 Quick Coupling Shaft for FNP System



7-131-20 Protection Sleeve for FNP System



7-131-21 Screw Caddy for FNP System

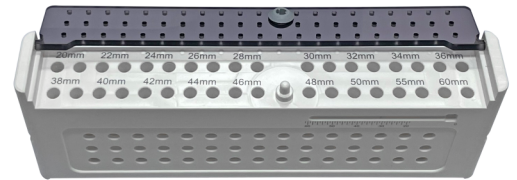

7-131-22 Implant Tray for 5.0mm Wise-Lock Femoral Neck Plate System

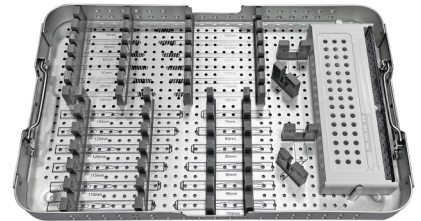

7-131-23 Instrument Tray for 5.0mm Wise-Lock Femoral Neck Plate System Instrument Set

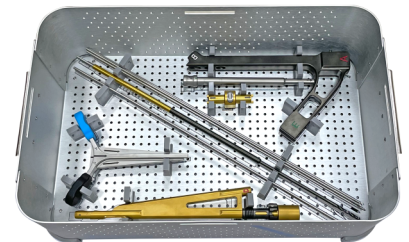
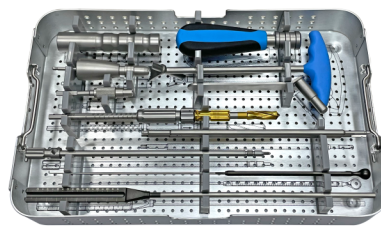

7-131-24 Container Wise-Lock Femoral Neck System Instrument Set

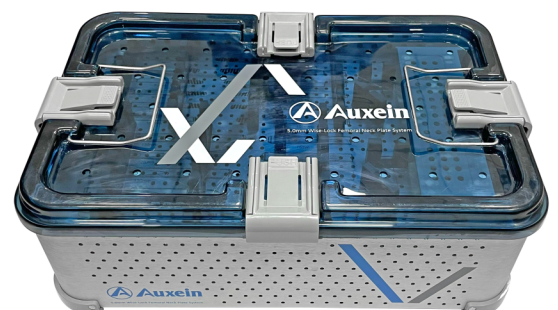

7-131 5.0mm Wise-Lock Femoral Neck Plate System Instrument Set

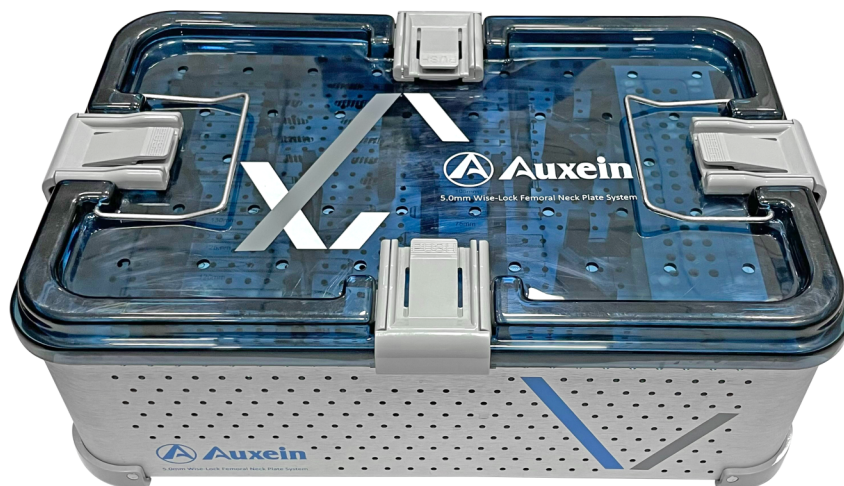
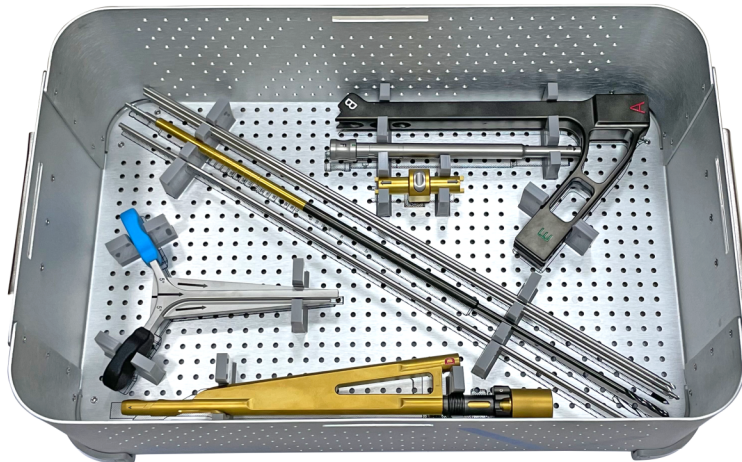
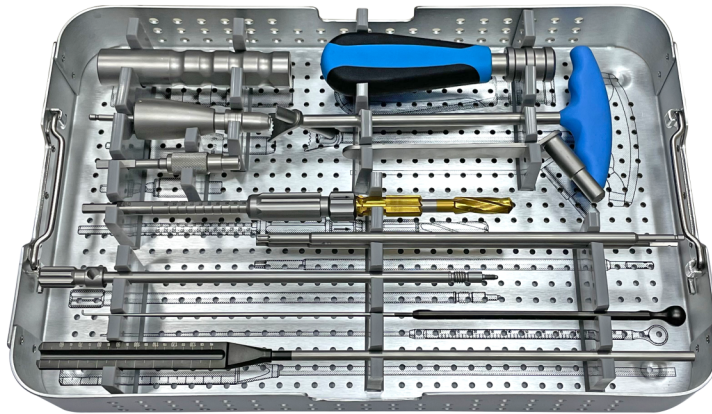

7-131 5.0mm Wise-Lock Femoral Neck Plate System Instrument Set

Code	Set Consisting of	Qty.
7-131-01	130° Angled Guide for FNP System	1
7-131-02	Correction Guide for FNP System	1
7-131-03	Guide Wire with Threaded Tip Ø3.2mm x Thread Length 14mm x Length 400mm	5
7-131-04	Guide Wire with One Side Trocar Tip Ø3.2mm x Length 400mm	2
7-131-05	Direct Measuring Device for FNP System	1
7-131-06	Reamer, Complete	1
7-131-07	Insertion Handle for FNP System	1
7-131-08	Insertor for FNP System	1
7-131-09	Multifunctional Rod for Insertion Instruments - FNP System	1
7-131-10	Drill Bit Ø4.3mm x Length 413mm, for FNP System	1
7-131-11	Stopper for Drill Bit Ø4.3mm, for FNP System	1
7-131-12	Protection Sleeve for Insertion Instruments - FNP System	1
7-131-13	Screwdriver Shaft, T25 for FNP System	1
7-131-14	Cylinder for Insertion Instruments - FNP System	1
7-131-15	Screwdriver Shaft, Hex 3.5mm, for FNP System	1
7-131-16	Depth Gauge measuring upto 100mm for FNP System	1
7-131-17	Large Handle with Quick Coupling for FNP System	1
7-131-18	Torque Limiting Attachment, 4.0Nm, for FNP System	1
7-131-19	Quick Coupling Shaft for FNP System	1
7-131-20	Protection Sleeve for FNP System	1
7-131-21	Screw Caddy for FNP System	1
7-131-22	Implant Tray for 5.0mm Wise-Lock Femoral Neck Plate System	1
7-131-23	Instrument Tray for 5.0mm Wise-Lock Femoral Neck Plate System Instrument Set	1
7-131-24	Container Wise-Lock Femoral Neck System Instrument Set	1



USA

Auxein Inc.
1500 Nw 89th Court, Suite 107-108
Doral, Florida 33172
Tel: +1 305 395 6062
E Fax: +1 305 395 6262
Email: USoffice@auxein.com

MEXICO

Auxein México, S.A. de C.V.
Tepic 139 int 801, Colonia Roma Sur,
Alcaldía Cuauhtémoc, CDMX,
México, C.P. 06760
Tel: +521 55 7261 0318
Email: info@auxein.mx

INDIA

Auxein Medical Pvt. Ltd.
Plot No. 168-169-170, Phase-4,
Kundli Industrial Area,
HSIIDC, Sector-57, Sonapat - 131028, Haryana
Tel: +91 99106 43638 | Fax: +91 86077 70197
Email: info@auxein.com