

KONZEPT FEMUR NAILING SYSTEM

KONZEPT FEMUR NAILING SYSTEM



about us

Auxein Medical is an integrated, research based, orthopaedic Implants & instruments manufacturing company, producing a wide range of quality, affordable generic implants, trusted by healthcare professionals and patients across geographies. It is the Company's constant endeavor to provide a wide basket of generic and our innovator products that exceed the highest expectations of customers in term of quality and safety. The company has world-class manufacturing unit established in india and serves customers in over 75 countries worldwide.

Our Achievements



Orthopaedic Implants

INTRODUCTION

AUXEIN system provides the following methods of intramedullary fixation:

- Reconstruction,
- Compression, dynamic, static,
- Retrograde (condylar approach).

Each fixation method of **AUXEIN** system comes with:

- Adequate selection of implants (intramedullary nails, screws, locking screws),
- Instrument sets for implants insertion and removal,

RECONSTRUCTION, PERTROCHANTERIC METHOD

Reconstruction nails are used for intramedullary fixation of proximal femur neck or trochanteric fractures.

Angular position of reconstruction screws gives anatomical position of the head and trochanteric region against the femur shaft. The nail comes in two versions: right nail for right femur, left nail for left femur.

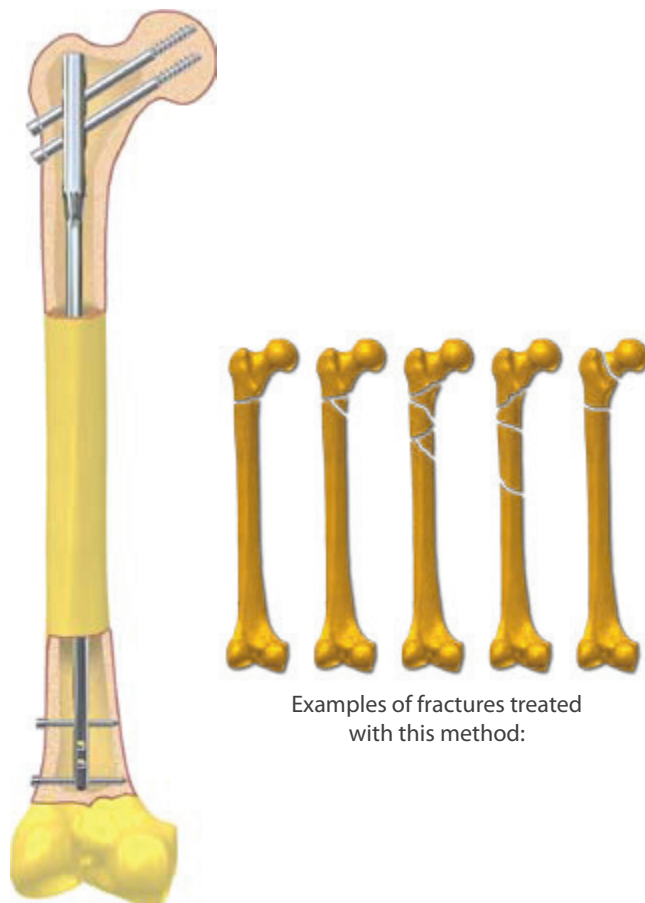

Examples of fractures treated with this method:

To fix the femur fracture fragments with pertrochanteric method use:

- right nail for fixation of the left femur fractures
- left nail for fixation of the right femur fractures

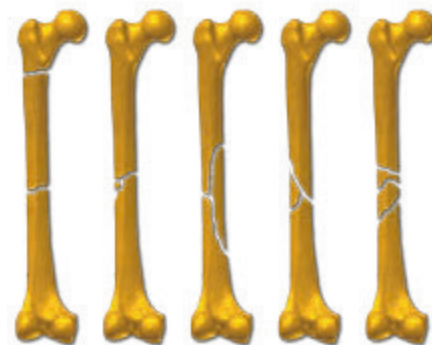

Examples of fractures treated with this method:

COMPRESSION, DYNAMIC AND STATIC METHOD

Compressive locking are used in the intramedullary fixations of femur shaft fractures, providing that fractures are not closer than 3cm from locking screw. Nail design allows treatment with the compression, dynamic and static method.

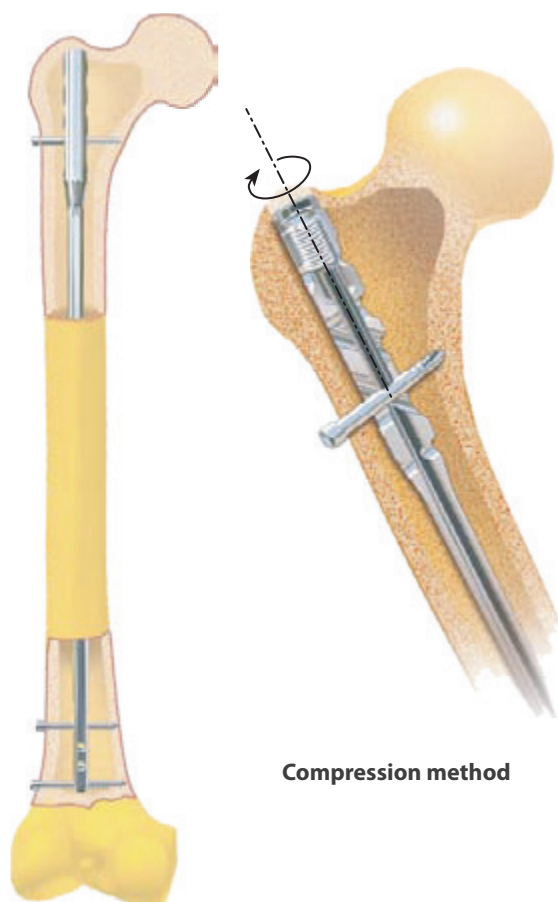

Compression method

In **static locking**, when needed, the proximal screw can be used to provide better locking.

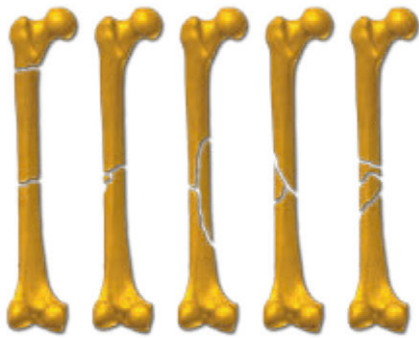

Examples of femoral shaft fractures treated with this method:

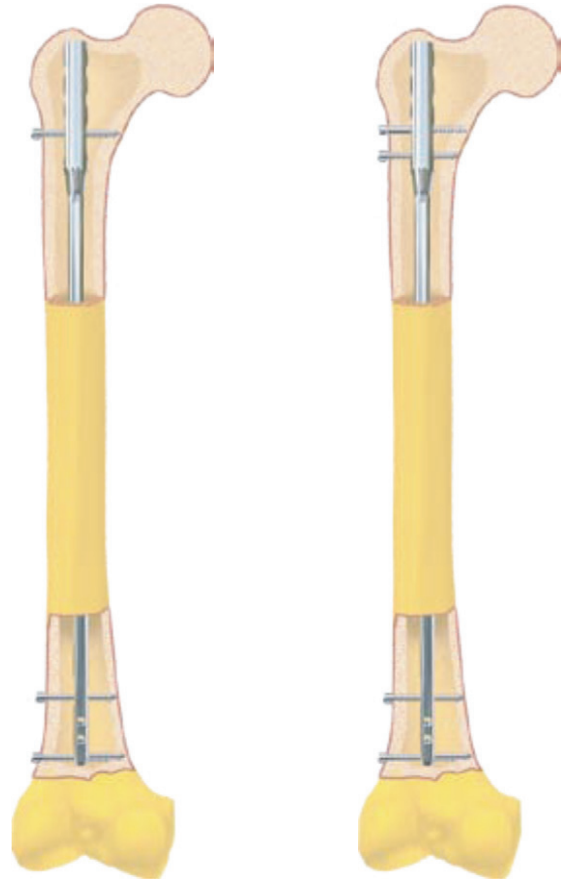

RETROGRADE (CONDYLAR APPROACH)

Intramedullary nails with condylar approach enable fixation in the distal part of femur in the case any other method (reconstruction, compression, dynamic, static) cannot be used. The reversed method can be used if prosthesis or other implant is located in the femur proximal or in case of condyle multifragmental fracture



Examples of femur shaft fractures treated with this method:

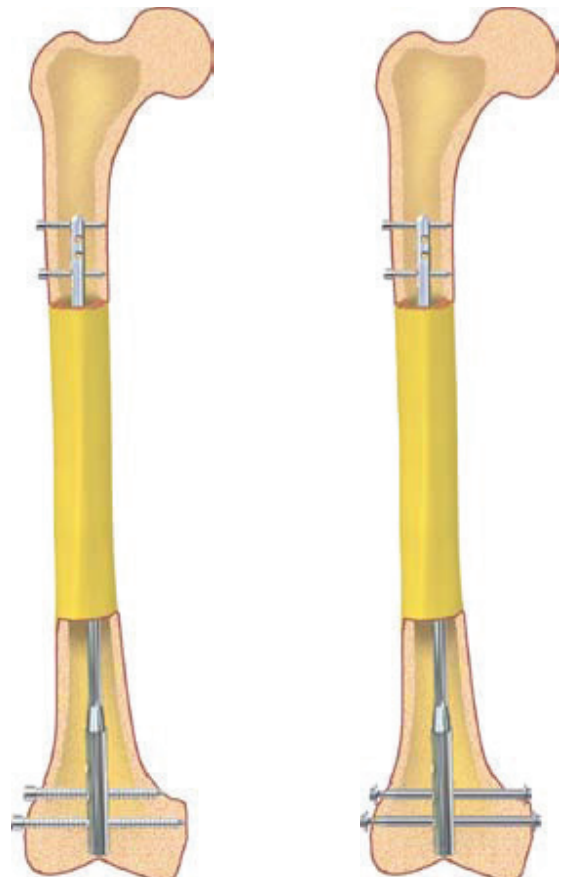

Universal Intramedullary Cannulated Femur Nail, Non Sterile



Ø Dia	Length (mm)	Stainless Steel (Left)	Titanium (Left)	Stainless Steel (Right)	Titanium (Right)
9mm	200	6081-9-200L	TI-6081-9-200L	6081-9-200R	TI-6081-9-200R
9mm	220	6081-9-220L	TI-6081-9-220L	6081-9-220R	TI-6081-9-220R
9mm	240	6081-9-240L	TI-6081-9-240L	6081-9-240R	TI-6081-9-240R
9mm	260	6081-9-260L	TI-6081-9-260L	6081-9-260R	TI-6081-9-260R
9mm	280	6081-9-280L	TI-6081-9-280L	6081-9-280R	TI-6081-9-280R
9mm	300	6081-9-300L	TI-6081-9-300L	6081-9-300R	TI-6081-9-300R
9mm	320	6081-9-320L	TI-6081-9-320L	6081-9-320R	TI-6081-9-320R
9mm	340	6081-9-340L	TI-6081-9-340L	6081-9-340R	TI-6081-9-340R
9mm	360	6081-9-360L	TI-6081-9-360L	6081-9-360R	TI-6081-9-360R
9mm	380	6081-9-380L	TI-6081-9-380L	6081-9-380R	TI-6081-9-380R
9mm	400	6081-9-400L	TI-6081-9-400L	6081-9-400R	TI-6081-9-400R
9mm	420	6081-9-420L	TI-6081-9-420L	6081-9-420R	TI-6081-9-420R
9mm	440	6081-9-440L	TI-6081-9-440L	6081-9-440R	TI-6081-9-440R
9mm	460	6081-9-460L	TI-6081-9-460L	6081-9-460R	TI-6081-9-460R
9mm	480	6081-9-480L	TI-6081-9-480L	6081-9-480R	TI-6081-9-480R
10mm	200	6081-10-200L	TI-6081-10-200L	6081-10-200R	TI-6081-10-200R
10mm	220	6081-10-220L	TI-6081-10-220L	6081-10-220R	TI-6081-10-220R
10mm	240	6081-10-240L	TI-6081-10-240L	6081-10-240R	TI-6081-10-240R
10mm	260	6081-10-260L	TI-6081-10-260L	6081-10-260R	TI-6081-10-260R
10mm	280	6081-10-280L	TI-6081-10-280L	6081-10-280R	TI-6081-10-280R
10mm	300	6081-10-300L	TI-6081-10-300L	6081-10-300R	TI-6081-10-300R
10mm	320	6081-10-320L	TI-6081-10-320L	6081-10-320R	TI-6081-10-320R
10mm	340	6081-10-340L	TI-6081-10-340L	6081-10-340R	TI-6081-10-340R
10mm	360	6081-10-360L	TI-6081-10-360L	6081-10-360R	TI-6081-10-360R
10mm	380	6081-10-380L	TI-6081-10-380L	6081-10-380R	TI-6081-10-380R
10mm	400	6081-10-400L	TI-6081-10-400L	6081-10-400R	TI-6081-10-400R
10mm	420	6081-10-420L	TI-6081-10-420L	6081-10-420R	TI-6081-10-420R
10mm	440	6081-10-440L	TI-6081-10-440L	6081-10-440R	TI-6081-10-440R
10mm	460	6081-10-460L	TI-6081-10-460L	6081-10-460R	TI-6081-10-460R
10mm	480	6081-10-480L	TI-6081-10-480L	6081-10-480R	TI-6081-10-480R
11mm	200	6081-11-200L	TI-6081-11-200L	6081-11-200R	TI-6081-11-200R
11mm	220	6081-11-220L	TI-6081-11-220L	6081-11-220R	TI-6081-11-220R
11mm	240	6081-11-240L	TI-6081-11-240L	6081-11-240R	TI-6081-11-240R
11mm	260	6081-11-260L	TI-6081-11-260L	6081-11-260R	TI-6081-11-260R
11mm	280	6081-11-280L	TI-6081-11-280L	6081-11-280R	TI-6081-11-280R



Ø Dia	Length (mm)	Stainless Steel (Left)	Titanium (Left)	Stainless Steel (Right)	Titanium (Right)
11mm	300	6081-11-300L	TI-6081-11-300L	6081-11-300R	TI-6081-11-300R
11mm	320	6081-11-320L	TI-6081-11-320L	6081-11-320R	TI-6081-11-320R
11mm	340	6081-11-340L	TI-6081-11-340L	6081-11-340R	TI-6081-11-340R
11mm	360	6081-11-360L	TI-6081-11-360L	6081-11-360R	TI-6081-11-360R
11mm	380	6081-11-380L	TI-6081-11-380L	6081-11-380R	TI-6081-11-380R
11mm	400	6081-11-400L	TI-6081-11-400L	6081-11-400R	TI-6081-11-400R
11mm	420	6081-11-420L	TI-6081-11-420L	6081-11-420R	TI-6081-11-420R
11mm	440	6081-11-440L	TI-6081-11-440L	6081-11-440R	TI-6081-11-440R
11mm	460	6081-11-460L	TI-6081-11-460L	6081-11-460R	TI-6081-11-460R
11mm	480	6081-11-480L	TI-6081-11-480L	6081-11-480R	TI-6081-11-480R
12mm	200	6081-12-200L	TI-6081-12-200L	6081-12-200R	TI-6081-12-200R
12mm	220	6081-12-220L	TI-6081-12-220L	6081-12-220R	TI-6081-12-220R
12mm	240	6081-12-240L	TI-6081-12-240L	6081-12-240R	TI-6081-12-240R
12mm	260	6081-12-260L	TI-6081-12-260L	6081-12-260R	TI-6081-12-260R
12mm	280	6081-12-280L	TI-6081-12-280L	6081-12-280R	TI-6081-12-280R
12mm	300	6081-12-300L	TI-6081-12-300L	6081-12-300R	TI-6081-12-300R
12mm	320	6081-12-320L	TI-6081-12-320L	6081-12-320R	TI-6081-12-320R
12mm	340	6081-12-340L	TI-6081-12-340L	6081-12-340R	TI-6081-12-340R
12mm	360	6081-12-360L	TI-6081-12-360L	6081-12-360R	TI-6081-12-360R
12mm	380	6081-12-380L	TI-6081-12-380L	6081-12-380R	TI-6081-12-380R
12mm	400	6081-12-400L	TI-6081-12-400L	6081-12-400R	TI-6081-12-400R
12mm	420	6081-12-420L	TI-6081-12-420L	6081-12-420R	TI-6081-12-420R
12mm	440	6081-12-440L	TI-6081-12-440L	6081-12-440R	TI-6081-12-440R
12mm	460	6081-12-460L	TI-6081-12-460L	6081-12-460R	TI-6081-12-460R
12mm	480	6081-12-480L	TI-6081-12-480L	6081-12-480R	TI-6081-12-480R
13mm	200	6081-13-200L	TI-6081-13-200L	6081-13-200R	TI-6081-13-200R
13mm	220	6081-13-220L	TI-6081-13-220L	6081-13-220R	TI-6081-13-220R
13mm	240	6081-13-240L	TI-6081-13-240L	6081-13-240R	TI-6081-13-240R
13mm	260	6081-13-260L	TI-6081-13-260L	6081-13-260R	TI-6081-13-260R
13mm	280	6081-13-280L	TI-6081-13-280L	6081-13-280R	TI-6081-13-280R
13mm	300	6081-13-300L	TI-6081-13-300L	6081-13-300R	TI-6081-13-300R
13mm	320	6081-13-320L	TI-6081-13-320L	6081-13-320R	TI-6081-13-320R
13mm	340	6081-13-340L	TI-6081-13-340L	6081-13-340R	TI-6081-13-340R
13mm	360	6081-13-360L	TI-6081-13-360L	6081-13-360R	TI-6081-13-360R
13mm	380	6081-13-380L	TI-6081-13-380L	6081-13-380R	TI-6081-13-380R

Ø Dia	Length (mm)	Stainless Steel (Left)	Titanium (Left)	Stainless Steel (Right)	Titanium (Right)
13mm	400	6081-13-400L	TI-6081-13-400L	6081-13-400R	TI-6081-13-400R
13mm	420	6081-13-420L	TI-6081-13-420L	6081-13-420R	TI-6081-13-420R
13mm	440	6081-13-440L	TI-6081-13-440L	6081-13-440R	TI-6081-13-440R
13mm	460	6081-13-460L	TI-6081-13-460L	6081-13-460R	TI-6081-13-460R
13mm	480	6081-13-480L	TI-6081-13-480L	6081-13-480R	TI-6081-13-480R
14mm	200	6081-14-200L	TI-6081-14-200L	6081-14-200R	TI-6081-14-200R
14mm	220	6081-14-220L	TI-6081-14-220L	6081-14-220R	TI-6081-14-220R
14mm	240	6081-14-240L	TI-6081-14-240L	6081-14-240R	TI-6081-14-240R
14mm	260	6081-14-260L	TI-6081-14-260L	6081-14-260R	TI-6081-14-260R
14mm	280	6081-14-280L	TI-6081-14-280L	6081-14-280R	TI-6081-14-280R
14mm	300	6081-14-300L	TI-6081-14-300L	6081-14-300R	TI-6081-14-300R
14mm	320	6081-14-320L	TI-6081-14-320L	6081-14-320R	TI-6081-14-320R
14mm	340	6081-14-340L	TI-6081-14-340L	6081-14-340R	TI-6081-14-340R
14mm	360	6081-14-360L	TI-6081-14-360L	6081-14-360R	TI-6081-14-360R
14mm	380	6081-14-380L	TI-6081-14-380L	6081-14-380R	TI-6081-14-380R
14mm	400	6081-14-400L	TI-6081-14-400L	6081-14-400R	TI-6081-14-400R
14mm	420	6081-14-420L	TI-6081-14-420L	6081-14-420R	TI-6081-14-420R
14mm	440	6081-14-440L	TI-6081-14-440L	6081-14-440R	TI-6081-14-440R
14mm	460	6081-14-460L	TI-6081-14-460L	6081-14-460R	TI-6081-14-460R
14mm	480	6081-14-480L	TI-6081-14-480L	6081-14-480R	TI-6081-14-480R

Universal Intramedullary Cannulated Femur Nail, Sterile

STERILE

Ø Dia	Length (mm)	Stainless Steel (Left)	Titanium (Left)	Stainless Steel (Right)	Titanium (Right)
9mm	200	6081-9-200L-S	TI-6081-9-200L-S	6081-9-200R-S	TI-6081-9-200R-S
9mm	220	6081-9-220L-S	TI-6081-9-220L-S	6081-9-220R-S	TI-6081-9-220R-S
9mm	240	6081-9-240L-S	TI-6081-9-240L-S	6081-9-240R-S	TI-6081-9-240R-S
9mm	260	6081-9-260L-S	TI-6081-9-260L-S	6081-9-260R-S	TI-6081-9-260R-S
9mm	280	6081-9-280L-S	TI-6081-9-280L-S	6081-9-280R-S	TI-6081-9-280R-S
9mm	300	6081-9-300L-S	TI-6081-9-300L-S	6081-9-300R-S	TI-6081-9-300R-S
9mm	320	6081-9-320L-S	TI-6081-9-320L-S	6081-9-320R-S	TI-6081-9-320R-S
9mm	340	6081-9-340L-S	TI-6081-9-340L-S	6081-9-340R-S	TI-6081-9-340R-S
9mm	360	6081-9-360L-S	TI-6081-9-360L-S	6081-9-360R-S	TI-6081-9-360R-S
9mm	380	6081-9-380L-S	TI-6081-9-380L-S	6081-9-380R-S	TI-6081-9-380R-S
9mm	400	6081-9-400L-S	TI-6081-9-400L-S	6081-9-400R-S	TI-6081-9-400R-S
9mm	420	6081-9-420L-S	TI-6081-9-420L-S	6081-9-420R-S	TI-6081-9-420R-S
9mm	440	6081-9-440L-S	TI-6081-9-440L-S	6081-9-440R-S	TI-6081-9-440R-S
9mm	460	6081-9-460L-S	TI-6081-9-460L-S	6081-9-460R-S	TI-6081-9-460R-S
9mm	480	6081-9-480L-S	TI-6081-9-480L-S	6081-9-480R-S	TI-6081-9-480R-S
10mm	200	6081-10-200L-S	TI-6081-10-200L-S	6081-10-200R-S	TI-6081-10-200R-S
10mm	220	6081-10-220L-S	TI-6081-10-220L-S	6081-10-220R-S	TI-6081-10-220R-S
10mm	240	6081-10-240L-S	TI-6081-10-240L-S	6081-10-240R-S	TI-6081-10-240R-S
10mm	260	6081-10-260L-S	TI-6081-10-260L-S	6081-10-260R-S	TI-6081-10-260R-S
10mm	280	6081-10-280L-S	TI-6081-10-280L-S	6081-10-280R-S	TI-6081-10-280R-S
10mm	300	6081-10-300L-S	TI-6081-10-300L-S	6081-10-300R-S	TI-6081-10-300R-S
10mm	320	6081-10-320L-S	TI-6081-10-320L-S	6081-10-320R-S	TI-6081-10-320R-S
10mm	340	6081-10-340L-S	TI-6081-10-340L-S	6081-10-340R-S	TI-6081-10-340R-S
10mm	360	6081-10-360L-S	TI-6081-10-360L-S	6081-10-360R-S	TI-6081-10-360R-S
10mm	380	6081-10-380L-S	TI-6081-10-380L-S	6081-10-380R-S	TI-6081-10-380R-S
10mm	400	6081-10-400L-S	TI-6081-10-400L-S	6081-10-400R-S	TI-6081-10-400R-S
10mm	420	6081-10-420L-S	TI-6081-10-420L-S	6081-10-420R-S	TI-6081-10-420R-S
10mm	440	6081-10-440L-S	TI-6081-10-440L-S	6081-10-440R-S	TI-6081-10-440R-S
10mm	460	6081-10-460L-S	TI-6081-10-460L-S	6081-10-460R-S	TI-6081-10-460R-S
10mm	480	6081-10-480L-S	TI-6081-10-480L-S	6081-10-480R-S	TI-6081-10-480R-S
11mm	200	6081-11-200L-S	TI-6081-11-200L-S	6081-11-200R-S	TI-6081-11-200R-S
11mm	220	6081-11-220L-S	TI-6081-11-220L-S	6081-11-220R-S	TI-6081-11-220R-S
11mm	240	6081-11-240L-S	TI-6081-11-240L-S	6081-11-240R-S	TI-6081-11-240R-S
11mm	260	6081-11-260L-S	TI-6081-11-260L-S	6081-11-260R-S	TI-6081-11-260R-S
11mm	280	6081-11-280L-S	TI-6081-11-280L-S	6081-11-280R-S	TI-6081-11-280R-S



Ø Dia	Length (mm)	Stainless Steel (Left)	Titanium (Left)	Stainless Steel (Right)	Titanium (Right)
11mm	300	6081-11-300L-S	TI-6081-11-300L-S	6081-11-300R-S	TI-6081-11-300R-S
11mm	320	6081-11-320L-S	TI-6081-11-320L-S	6081-11-320R-S	TI-6081-11-320R-S
11mm	340	6081-11-340L-S	TI-6081-11-340L-S	6081-11-340R-S	TI-6081-11-340R-S
11mm	360	6081-11-360L-S	TI-6081-11-360L-S	6081-11-360R-S	TI-6081-11-360R-S
11mm	380	6081-11-380L-S	TI-6081-11-380L-S	6081-11-380R-S	TI-6081-11-380R-S
11mm	400	6081-11-400L-S	TI-6081-11-400L-S	6081-11-400R-S	TI-6081-11-400R-S
11mm	420	6081-11-420L-S	TI-6081-11-420L-S	6081-11-420R-S	TI-6081-11-420R-S
11mm	440	6081-11-440L-S	TI-6081-11-440L-S	6081-11-440R-S	TI-6081-11-440R-S
11mm	460	6081-11-460L-S	TI-6081-11-460L-S	6081-11-460R-S	TI-6081-11-460R-S
11mm	480	6081-11-480L-S	TI-6081-11-480L-S	6081-11-480R-S	TI-6081-11-480R-S
12mm	200	6081-12-200L-S	TI-6081-12-200L-S	6081-12-200R-S	TI-6081-12-200R-S
12mm	220	6081-12-220L-S	TI-6081-12-220L-S	6081-12-220R-S	TI-6081-12-220R-S
12mm	240	6081-12-240L-S	TI-6081-12-240L-S	6081-12-240R-S	TI-6081-12-240R-S
12mm	260	6081-12-260L-S	TI-6081-12-260L-S	6081-12-260R-S	TI-6081-12-260R-S
12mm	280	6081-12-280L-S	TI-6081-12-280L-S	6081-12-280R-S	TI-6081-12-280R-S
12mm	300	6081-12-300L-S	TI-6081-12-300L-S	6081-12-300R-S	TI-6081-12-300R-S
12mm	320	6081-12-320L-S	TI-6081-12-320L-S	6081-12-320R-S	TI-6081-12-320R-S
12mm	340	6081-12-340L-S	TI-6081-12-340L-S	6081-12-340R-S	TI-6081-12-340R-S
12mm	360	6081-12-360L-S	TI-6081-12-360L-S	6081-12-360R-S	TI-6081-12-360R-S
12mm	380	6081-12-380L-S	TI-6081-12-380L-S	6081-12-380R-S	TI-6081-12-380R-S
12mm	400	6081-12-400L-S	TI-6081-12-400L-S	6081-12-400R-S	TI-6081-12-400R-S
12mm	420	6081-12-420L-S	TI-6081-12-420L-S	6081-12-420R-S	TI-6081-12-420R-S
12mm	440	6081-12-440L-S	TI-6081-12-440L-S	6081-12-440R-S	TI-6081-12-440R-S
12mm	460	6081-12-460L-S	TI-6081-12-460L-S	6081-12-460R-S	TI-6081-12-460R-S
12mm	480	6081-12-480L-S	TI-6081-12-480L-S	6081-12-480R-S	TI-6081-12-480R-S
13mm	200	6081-13-200L-S	TI-6081-13-200L-S	6081-13-200R-S	TI-6081-13-200R-S
13mm	220	6081-13-220L-S	TI-6081-13-220L-S	6081-13-220R-S	TI-6081-13-220R-S
13mm	240	6081-13-240L-S	TI-6081-13-240L-S	6081-13-240R-S	TI-6081-13-240R-S
13mm	260	6081-13-260L-S	TI-6081-13-260L-S	6081-13-260R-S	TI-6081-13-260R-S
13mm	280	6081-13-280L-S	TI-6081-13-280L-S	6081-13-280R-S	TI-6081-13-280R-S
13mm	300	6081-13-300L-S	TI-6081-13-300L-S	6081-13-300R-S	TI-6081-13-300R-S
13mm	320	6081-13-320L-S	TI-6081-13-320L-S	6081-13-320R-S	TI-6081-13-320R-S
13mm	340	6081-13-340L-S	TI-6081-13-340L-S	6081-13-340R-S	TI-6081-13-340R-S
13mm	360	6081-13-360L-S	TI-6081-13-360L-S	6081-13-360R-S	TI-6081-13-360R-S
13mm	380	6081-13-380L-S	TI-6081-13-380L-S	6081-13-380R-S	TI-6081-13-380R-S

Ø Dia	Length (mm)	Stainless Steel (Left)	Titanium (Left)	Stainless Steel (Right)	Titanium (Right)
13mm	400	6081-13-400L-S	TI-6081-13-400L-S	6081-13-400R-S	TI-6081-13-400R-S
13mm	420	6081-13-420L-S	TI-6081-13-420L-S	6081-13-420R-S	TI-6081-13-420R-S
13mm	440	6081-13-440L-S	TI-6081-13-440L-S	6081-13-440R-S	TI-6081-13-440R-S
13mm	460	6081-13-460L-S	TI-6081-13-460L-S	6081-13-460R-S	TI-6081-13-460R-S
13mm	480	6081-13-480L-S	TI-6081-13-480L-S	6081-13-480R-S	TI-6081-13-480R-S
14mm	200	6081-14-200L-S	TI-6081-14-200L-S	6081-14-200R-S	TI-6081-14-200R-S
14mm	220	6081-14-220L-S	TI-6081-14-220L-S	6081-14-220R-S	TI-6081-14-220R-S
14mm	240	6081-14-240L-S	TI-6081-14-240L-S	6081-14-240R-S	TI-6081-14-240R-S
14mm	260	6081-14-260L-S	TI-6081-14-260L-S	6081-14-260R-S	TI-6081-14-260R-S
14mm	280	6081-14-280L-S	TI-6081-14-280L-S	6081-14-280R-S	TI-6081-14-280R-S
14mm	300	6081-14-300L-S	TI-6081-14-300L-S	6081-14-300R-S	TI-6081-14-300R-S
14mm	320	6081-14-320L-S	TI-6081-14-320L-S	6081-14-320R-S	TI-6081-14-320R-S
14mm	340	6081-14-340L-S	TI-6081-14-340L-S	6081-14-340R-S	TI-6081-14-340R-S
14mm	360	6081-14-360L-S	TI-6081-14-360L-S	6081-14-360R-S	TI-6081-14-360R-S
14mm	380	6081-14-380L-S	TI-6081-14-380L-S	6081-14-380R-S	TI-6081-14-380R-S
14mm	400	6081-14-400L-S	TI-6081-14-400L-S	6081-14-400R-S	TI-6081-14-400R-S
14mm	420	6081-14-420L-S	TI-6081-14-420L-S	6081-14-420R-S	TI-6081-14-420R-S
14mm	440	6081-14-440L-S	TI-6081-14-440L-S	6081-14-440R-S	TI-6081-14-440R-S
14mm	460	6081-14-460L-S	TI-6081-14-460L-S	6081-14-460R-S	TI-6081-14-460R-S
14mm	480	6081-14-480L-S	TI-6081-14-480L-S	6081-14-480R-S	TI-6081-14-480R-S

End Cap For Universal Intramedullary Cannulated Femur Nail M10x1

STERILE



Length	Stainless Steel	Titanium
0mm	2100-0-S	TI-2100-0-S
5mm	2100-5-S	TI-2100-5-S
10mm	2100-10-S	TI-2100-10-S
15mm	2100-15-S	TI-2100-15-S

Length	Stainless Steel	Titanium
0mm	2100-0	TI-2100-0
5mm	2100-5	TI-2100-5
10mm	2100-10	TI-2100-10
15mm	2100-15	TI-2100-15



Compression Screw For Universal Intramedullary Cannulated Femur Nail

STERILE



Stainless Steel	Titanium
2102-00-S	TI-2102-00-S

Stainless Steel	Titanium
2102-00	TI-2102-00



6.5mm Cannulated Reconstruction Screw For Universal Intramedullary Cannulated Femur Nail

STERILE



Length	Stainless Steel	Titanium
60mm	6090.060-S	TI-6090.060-S
65mm	6090.065-S	TI-6090.065-S
70mm	6090.070-S	TI-6090.070-S
75mm	6090.075-S	TI-6090.075-S
80mm	6090.080-S	TI-6090.080-S
85mm	6090.085-S	TI-6090.085-S
90mm	6090.090-S	TI-6090.090-S
95mm	6090.095-S	TI-6090.095-S
100mm	6090.100-S	TI-6090.100-S
105mm	6090.105-S	TI-6090.105-S
110mm	6090.110-S	TI-6090.110-S
115mm	6090.115-S	TI-6090.115-S
120mm	6090.120-S	TI-6090.120-S

Length	Stainless Steel	Titanium
60mm	6090.060	TI-6090.060
65mm	6090.065	TI-6090.065
70mm	6090.070	TI-6090.070
75mm	6090.075	TI-6090.075
80mm	6090.080	TI-6090.080
85mm	6090.085	TI-6090.085
90mm	6090.090	TI-6090.090
95mm	6090.095	TI-6090.095
100mm	6090.100	TI-6090.100
105mm	6090.105	TI-6090.105
110mm	6090.110	TI-6090.110
115mm	6090.115	TI-6090.115
120mm	6090.120	TI-6090.120



4.5mm Locking Bolt For Universal Intramedullary Cannulated Femur Nail

STERILE

Length	Stainless Steel	Titanium
30mm	1-012-030SS-S	1-012-030TI-S
35mm	1-012-035SS-S	1-012-035TI-S
40mm	1-012-040SS-S	1-012-040TI-S
45mm	1-012-045SS-S	1-012-045TI-S
50mm	1-012-050SS-S	1-012-050TI-S
55mm	1-012-055SS-S	1-012-055TI-S
60mm	1-012-060SS-S	1-012-060TI-S
65mm	1-012-065SS-S	1-012-065TI-S
70mm	1-012-070SS-S	1-012-070TI-S
75mm	1-012-075SS-S	1-012-075TI-S
80mm	1-012-080SS-S	1-012-080TI-S
85mm	1-012-085SS-S	1-012-085TI-S
90mm	1-012-090SS-S	1-012-090TI-S

Length	Stainless Steel	Titanium
30mm	1-012-030SS	1-012-030TI
35mm	1-012-035SS	1-012-035TI
40mm	1-012-040SS	1-012-040TI
45mm	1-012-045SS	1-012-045TI
50mm	1-012-050SS	1-012-050TI
55mm	1-012-055SS	1-012-055TI
60mm	1-012-060SS	1-012-060TI
65mm	1-012-065SS	1-012-065TI
70mm	1-012-070SS	1-012-070TI
75mm	1-012-075SS	1-012-075TI
80mm	1-012-080SS	1-012-080TI
85mm	1-012-085SS	1-012-085TI
90mm	1-012-090SS	1-012-090TI



6.5mm Locking Bolt for Universal Intramedullary Cannulated Femur Nail, Full Thread

STERILE

Length	Stainless Steel	Titanium
40mm	6088.040-S	TI-6088.040-S
45mm	6088.045-S	TI-6088.045-S
50mm	6088.050-S	TI-6088.050-S
55mm	6088.055-S	TI-6088.055-S
60mm	6088.060-S	TI-6088.060-S
65mm	6088.065-S	TI-6088.065-S
70mm	6088.070-S	TI-6088.070-S
75mm	6088.075-S	TI-6088.075-S
80mm	6088.080-S	TI-6088.080-S
85mm	6088.085-S	TI-6088.085-S
90mm	6088.090-S	TI-6088.090-S
95mm	6088.095-S	TI-6088.095-S
100mm	6088.100-S	TI-6088.100-S
105mm	6088.105-S	TI-6088.105-S
110mm	6088.110-S	TI-6088.110-S

Length	Stainless Steel	Titanium
40mm	6088.040	TI-6088.040
45mm	6088.045	TI-6088.045
50mm	6088.050	TI-6088.050
55mm	6088.055	TI-6088.055
60mm	6088.060	TI-6088.060
65mm	6088.065	TI-6088.065
70mm	6088.070	TI-6088.070
75mm	6088.075	TI-6088.075
80mm	6088.080	TI-6088.080
85mm	6088.085	TI-6088.085
90mm	6088.090	TI-6088.090
95mm	6088.095	TI-6088.095
100mm	6088.100	TI-6088.100
105mm	6088.105	TI-6088.105
110mm	6088.110	TI-6088.110



**6.5mm Blocking set for Universal Intramedullary
Cannulated Femur Nail**
STERILE

Length	Stainless Steel	Titanium
50mm	2107-50-S	TI-2107-50-S
60mm	2107-60-S	TI-2107-60-S
70mm	2107-70-S	TI-2107-70-S
80mm	2107-80-S	TI-2107-80-S
90mm	2107-90-S	TI-2107-90-S

Length	Stainless Steel	Titanium
50mm	2107-50	TI-2107-50
60mm	2107-60	TI-2107-60
70mm	2107-70	TI-2107-70
80mm	2107-80	TI-2107-80
90mm	2107-90	TI-2107-90



2313-01 Targeter Arm for Konzept Femur Nail



2313-02 Targeter 135° for Konzept Femur Nail



2313-03 Distal Target D for Konzept Femur Nail



2313-04 Connecting Screw M10x1 Length 55mm, for Konzept Femur Nail



2313-05 Connecting Screw M10x1 Length 66mm for Konzept Femur Nail



2313-06 Compression Screw for Konzept Femur Nail



2313-07 Nail Length Measuring Device for Konzept Femur Nail

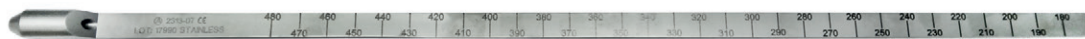

2313-08 Trocar Ø9mm for Konzept Femur Nail



2313-09 Protective Guide Ø11/9mm for Konzept Femur Nail



2313-10 Drill Guide Ø9/6.5mm for Konzept Femur Nail



2313-11 Drill Guide Ø9/4.5mm for Konzept Femur Nail



2313-12 Kirschner Guide for Konzept Femur Nail



2313-13 Reconstruction Screw Length Measuring Device for Konzept Femur Nail



2313-14 Kirschner Wire Ø2.0mm x Length 380mm for Konzept Femur Nail



2313-15 Protective Guide Ø9/6.5mm for Konzept Femur Nail



2313-16 Drill Guide Ø6.5/3.5mm for Konzept Femur Nail



2313-17 Set Block Ø9/4.5mm for Konzept Femur Nail



2313-18 Trocar Ø6.5mm for Konzept Femur Nail



2313-19 Drill Guide Ø6.5/4.5mm for Konzept Femur Nail



2313-20 Screw Length Measuring Device for Konzept Femur Nail



2313-21 Curved Awl Ø8.0mm for Konzept Femur Nail



2313-22 Impactor-Extractor Rod for Konzept Femur Nail



2313-23 Mallet for Konzept Femur Nail



2313-24 Connector M10 x 1/M12 for Konzept Femur Nail



2313-25 Universal Wrench S10 for Konzept Femur Nail



2313-26 Teflon Pipe Guide for Konzept Femur Nail



2313-27 Guide Rod Ø3.0mm x Length 580mm for Konzept Femur Nail



2313-28 Guide Rod Handle for Konzept Femur Nail



2313-29 Screwdriver, Hex 3.5mm, for Konzept Femur Nail



2313-30 Drill with Scale Ø4.5mm x Length 350mm, for Konzept Femur Nail



2313-31 Drill with Scale Ø3.5mm x Length 250mm, for Konzept Femur Nail



2313-32 Drill Ø6.5mm x Length 350mm, for Konzept Femur Nail



2313-65 Cannulated Drill Ø6.5mm x Length 350mm, for Konzept Femur Nail



2313-34 Cannulated Screwdriver, Hex 5.0mm, for Konzept Femur Nail



2313-35 Cannulated Screw Length Measuring Device for Konzept Femur Nail



2313-36 Aiming Insert Ø9.0mm for Konzept Femur Nail



2313-37 Aiming Insert Ø11.0mm for Konzept Femur Nail



2313-38 Screwdriver with T- Handle, Hex 3.5mm, for Konzept Femur Nail



2313-39 Bolt Guide with T- Handle for Konzept Femur Nail



2313-40 Drill Ø4.5mm x 250mm, for Konzept Femur Nail



2313-44 Protective Guide Ø11/9mm, Short, for Konzept Femur Nail



2313-46 Angle Block for Konzept Femur Nail

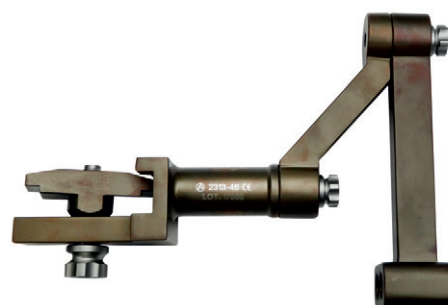

7-106-04

L Pin wrench

**2313-66-A**

Instrument Tray A for Konzept Femur Nailing Instrument Set

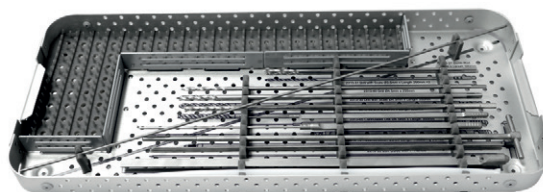
**2313-66-B**

Instrument Tray B for Konzept Femur Nailing Instrument Set

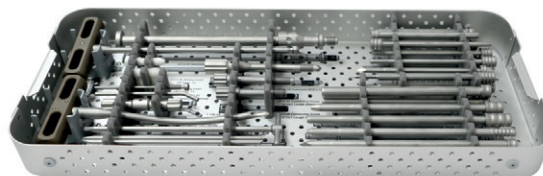
**2313-66-C**

Instrument Tray C for Konzept Femur Nailing Instrument Set

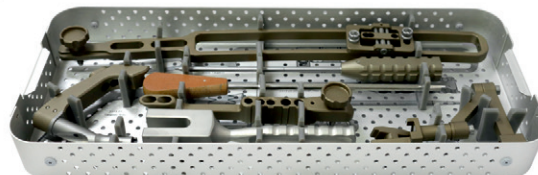
**2313-67**

Container with Lid for Konzept Femur Nailing Instrument Set



2313-00 Konzept Femur Nailing Instrument Set

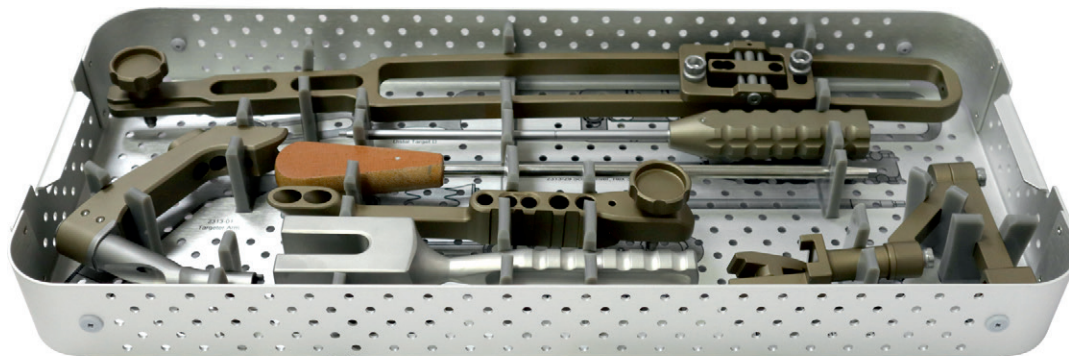
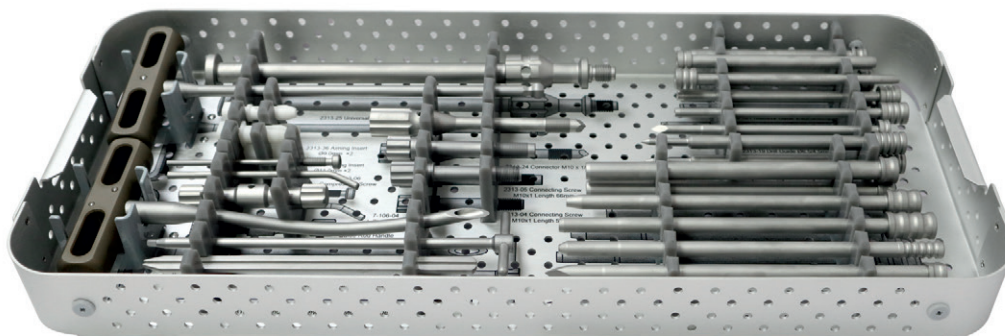
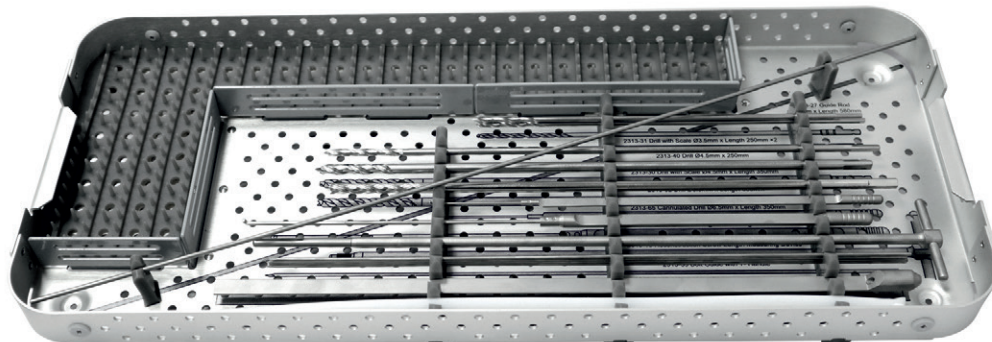

2313-00 Konzept Femur Nailing Instrument Set

Code	Set Consisting of	Units
2313-01	Targeter Arm for Konzept Femur Nail	1
2313-02	Targeter 135° for Konzept Femur Nail	1
2313-03	Distal Target D for Konzept Femur Nail	1
2313-04	Connecting Screw M10x1 Length 55mm, for Konzept Femur Nail	1
2313-05	Connecting Screw M10x1 Length 66mm for Konzept Femur Nail	1
2313-06	Compression Screw for Konzept Femur Nail	1
2313-07	Nail Length Measuring Device for Konzept Femur Nail	1
2313-08	Trocar Ø9mm for Konzept Femur Nail	1
2313-09	Protective Guide Ø11/9mm for Konzept Femur Nail	2
2313-10	Drill Guide Ø9/6.5mm for Konzept Femur Nail	1
2313-11	Drill Guide Ø9/4.5mm for Konzept Femur Nail	1
2313-12	Kirschner Guide for Konzept Femur Nail	1
2313-13	Reconstruction Screw Length Measuring Device for Konzept Femur Nail	1
2313-14	Kirschner Wire Ø2.0mm x Length 380mm for Konzept Femur Nail	4
2313-15	Protective Guide Ø9/6.5mm for Konzept Femur Nail	3
2313-16	Drill Guide Ø6.5/3.5mm for Konzept Femur Nail	3
2313-17	Set Block Ø9/4.5mm for Konzept Femur Nail	2
2313-18	Trocar Ø6.5mm for Konzept Femur Nail	1
2313-19	Drill Guide Ø6.5/4.5mm for Konzept Femur Nail	1
2313-20	Screw Length Measuring Device for Konzept Femur Nail	1
2313-21	Curved Awl Ø8.0mm for Konzept Femur Nail	1
2313-22	Impactor-Extractor Rod for Konzept Femur Nail	1
2313-23	Mallet for Konzept Femur Nail	1
2313-24	Connector M10 x 1/M12 for Konzept Femur Nail	1
2313-25	Universal Wrench S10 for Konzept Femur Nail	1
2313-26	Teflon Pipe Guide for Konzept Femur Nail	1
2313-27	Guide Rod Ø3.0mm x Length 580mm for Konzept Femur Nail	1
2313-28	Guide Rod Handle for Konzept Femur Nail	1
2313-29	Screwdriver, Hex 3.5mm, for Konzept Femur Nail	1
2313-30	Drill with Scale Ø4.5mm x Length 350mm, for Konzept Femur Nail	1
2313-31	Drill with Scale Ø3.5mm x Length 250mm, for Konzept Femur Nail	2
2313-32	Drill Ø6.5mm x Length 350mm, for Konzept Femur Nail	1
2313-65	Cannulated Drill Ø6.5mm x Length 350mm, for Konzept Femur Nail	1
2313-34	Cannulated Screwdriver, Hex 5.0mm, for Konzept Femur Nail	1

Code	Set Consisting of	Units
2313-35	Cannulated Screw Length Measuring Device for Konzept Femur Nail	1
2313-36	Aiming Insert Ø9.0mm for Konzept Femur Nail	2
2313-37	Aiming Insert Ø11.0mm for Konzept Femur Nail	2
2313-38	Screwdriver with T- Handle, Hex 3.5mm, for Konzept Femur Nail	1
2313-39	Bolt Guide with T- Handle for Konzept Femur Nail	1
2313-40	Drill Ø4.5mm x 250mm, for Konzept Femur Nail	1
2313-44	Protective Guide Ø11/9mm, Short, for Konzept Femur Nail	1
2313-46	Angle Block for Konzept Femur Nail	1
7-106-04	L Pin wrench	1
2313-66-A	Instrument Tray A for Konzept Femur Nailing Instrument Set	1
2313-66-B	Instrument Tray B for Konzept Femur Nailing Instrument Set	1
2313-66-C	Instrument Tray C for Konzept Femur Nailing Instrument Set	1
2313-67	Container with Lid for Konzept Femur Nailing Instrument Set	1



USA

Auxein Inc.
1500 Nw 89th Court, Suite 107-108
Doral, Florida 33172
Tel: +1 305 395 6062
E Fax: +1 305 395 6262
Email: USoffice@auxein.com

MEXICO

Auxein México, S.A. de C.V.
Tepic 139 int 801, Colonia Roma Sur,
Alcaldía Cuauhtémoc, CDMX,
México, C.P. 06760
Tel: +521 55 7261 0318
Email: info@auxein.mx

INDIA

Auxein Medical Pvt. Ltd.
Plot No. 168-169-170, Phase-4,
Kundli Industrial Area,
HSIIDC, Sector-57, Sonapat - 131028, Haryana
Tel: +91 99106 43638 | Fax: +91 86077 70197
Email: info@auxein.com