

AUXILOCK[®]
GFS ULTIMATE
MINI

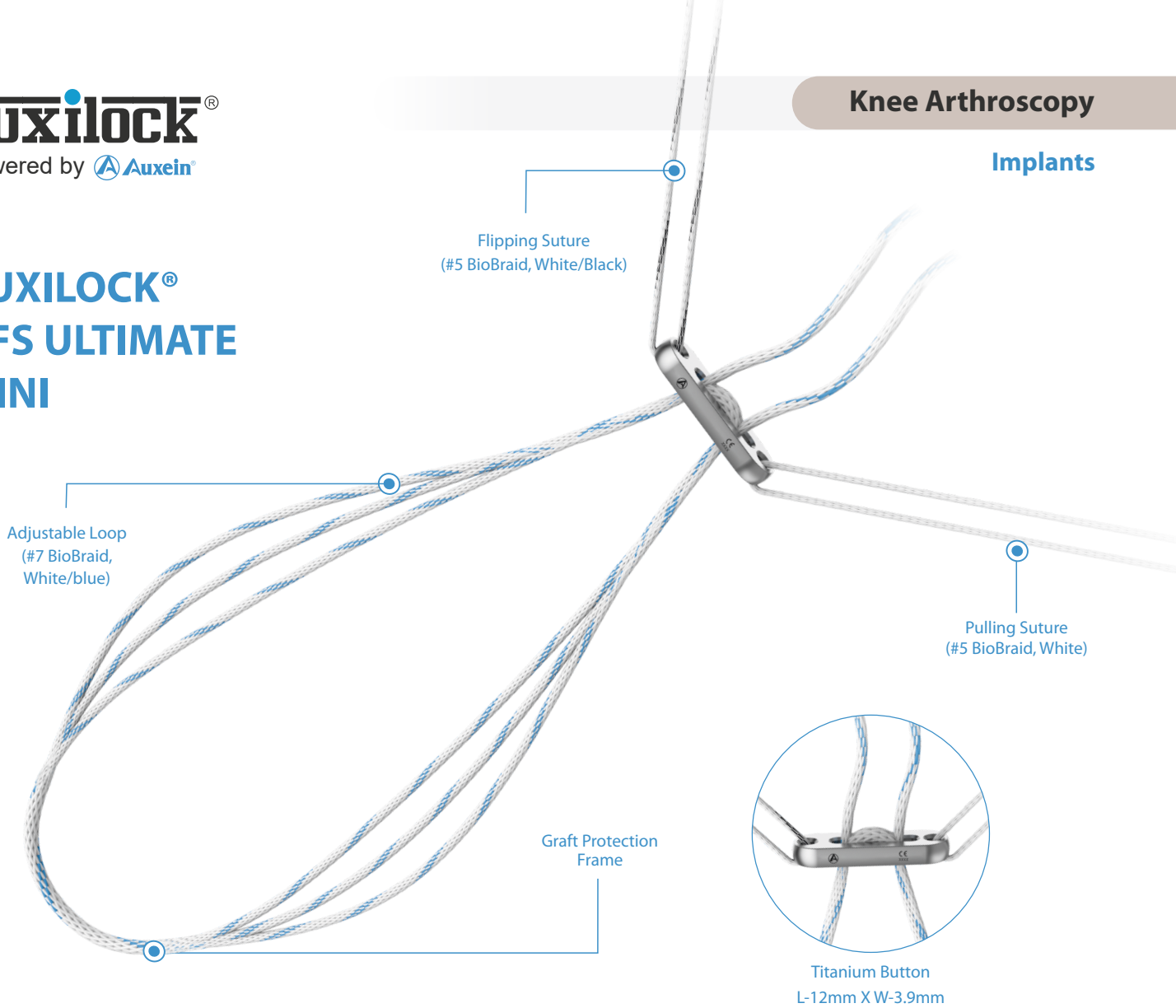

GFS Ultimate Mini is an adjustable loop with an oblong shaped titanium button used for Cruciate Graft Reconstructions. GFS Ultimate provides a double locking mechanism that eliminates the need for knot tying.

GFS Ultimate Mini provides three sutures (UHMWPE):

- Adjustable Suture (#7, White/Blue): It allows the surgeon to maximize the amount of graft inside the femoral tunnel, thereby optimizing the healing process. It also enables the calibration of the loop to its optimum size.
- Pulling Suture (#5, White): It is available to pull the graft inside the tunnel.
- Flipping Suture (#5, White/Black): It ensures the flipping of the button.

Ordering Information

Code	Product Description	Length of Loop (mm)
6-006-01	AUXILOCK [®] GFS Ultimate Mini Button, Button L: 12mm, W: 3.9mm (Adjustable Loop)	Max: 70, Min: 12

Recommended Instrumentation

Code	Product Description
7-013-57	Ø4.5mm Cannulated Headed Reamer

STERILE EO

AUXILOCK[®] GFS ULTIMATE LARGE

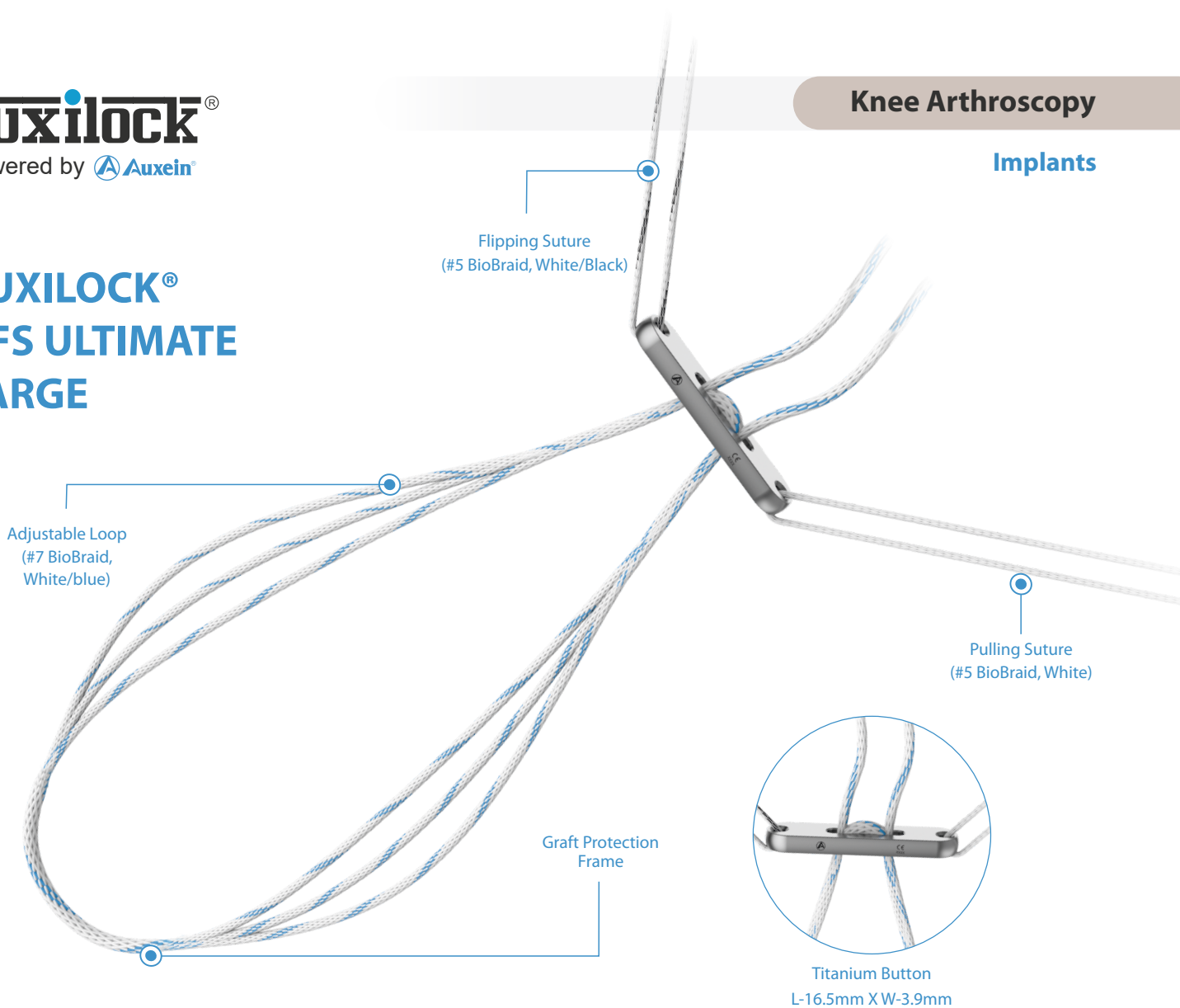

GFS Ultimate Large is an adjustable loop with an oblong shaped titanium button used for Cruciate Graft Reconstructions. GFS Ultimate provides a double locking mechanism which eliminates the need for knot tying. Hence, GFS Ultimate Large is considered an excellent choice for revision surgeries.

GFS Ultimate Large provides three sutures (UHMWPE):

- Adjustable Suture (#7, White/Blue): It allows the surgeon to maximize the amount of graft inside the femoral tunnel, thereby optimizing the healing process. It also enables the calibration of the loop to its optimum size.
- Pulling Suture (#5, White): It is available to pull the graft inside the tunnel.
- Flipping Suture (#5, White/Black): It ensures the flipping of the button.

Ordering Information

Code	Product Description	Length of Loop (mm)
6-006-02	AUXILOCK [®] GFS Ultimate Large Button, Button L: 16.5mm, W: 3.9mm (Adjustable Loop)	Max: 70, Min: 12

Recommended Instrumentation

Code	Product Description
7-013-57	Ø4.5mm Cannulated Headed Reamer

STERILE EO

AUXILOCK[®] GFS NO-BUTTON ADJUSTABLE LOOP

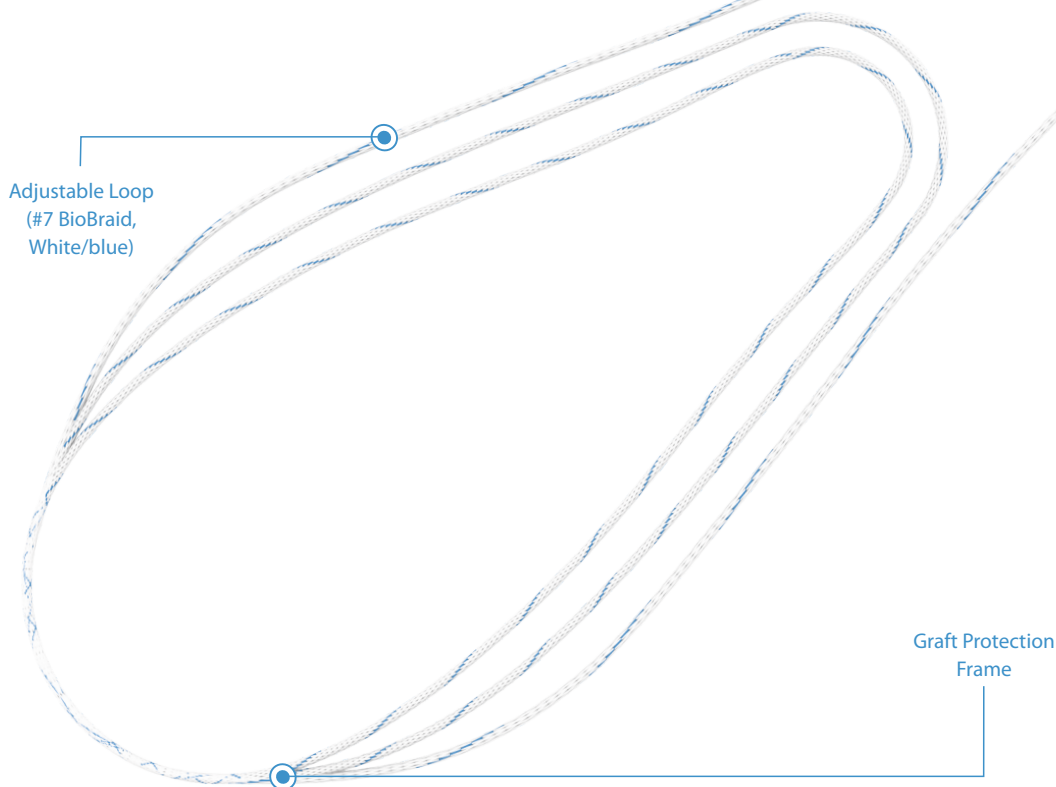

GFS No-Button is an adjustable loop without a button used for Cruciate Graft Reconstructions. The adjustable Loop is made of UHMWPE (Ultra High Molecular Weight Polyethylene).

- Adjustable Suture (#7, White/Blue): It allows the surgeon to maximize the amount of graft inside the femoral tunnel, thereby optimizing the healing process. It also enables the calibration of the loop to its optimum size.

Ordering Information

Code	Product Description	Length of Loop (mm)
6-049-01	AUXILOCK [®] GFS No-Button Adjustable Loop	Max: 70, Min: 12

STERILE EO

AUXILOCK[®]
GFS MINI

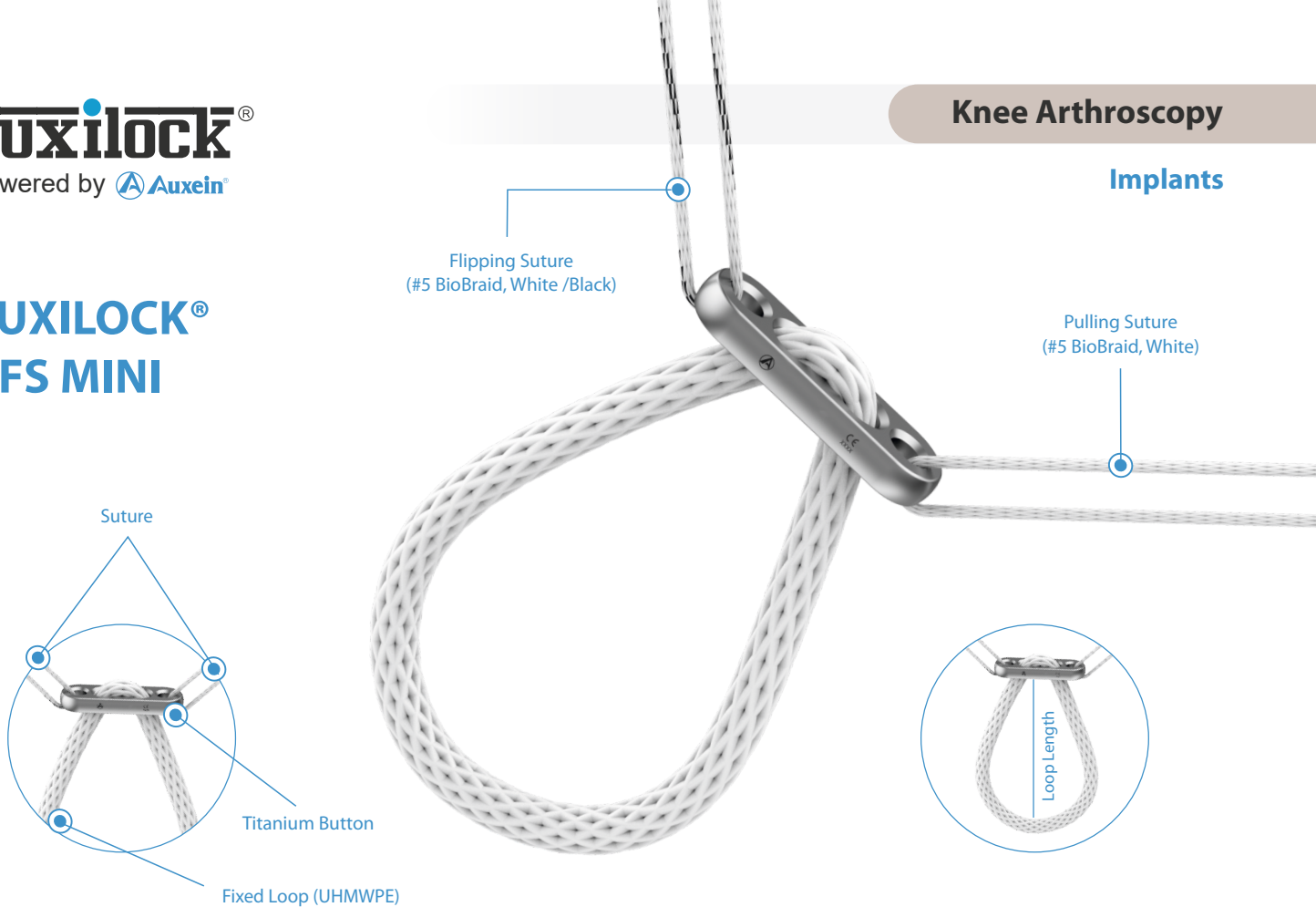

GFS Mini is a fixed loop with an oblong shaped button used for Graft Fixations in ACL/PCL Reconstruction. Being a continuous loop without any joint, GFS Mini provides a stronger fixation while eliminating the need for knot tying. The pre-loaded pulling and flipping braided sutures are available to ensure controlled pulling and flipping of the button in the transosseous tunnel. A 4.5mm cannulated headed reamer is provided in the instrument set for drilling the tunnel, allowing the GFS Mini button to pass easily into it. The fixed loop is made of UHMWPE (Ultra High Molecular Weight Polyethylene) and the oblong Button is made of titanium material.

- Pulling Suture (#5, White) : It is available to pull the graft inside the tunnel.
- Flipping Suture (#5, White/Black) : It ensures the flipping of the button.

Ordering Information

Code	Product Description
6-007-01	AUXILOCK [®] GFS Mini, Loop: 12mm, Button L: 12mm, W: 3.9mm
6-007-02	AUXILOCK [®] GFS Mini, Loop: 15mm, Button L: 12mm, W: 3.9mm
6-007-03	AUXILOCK [®] GFS Mini, Loop: 20mm, Button L: 12mm, W: 3.9mm
6-007-04	AUXILOCK [®] GFS Mini, Loop: 25mm, Button L: 12mm, W: 3.9mm
6-007-05	AUXILOCK [®] GFS Mini, Loop: 30mm, Button L: 12mm, W: 3.9mm
6-007-06	AUXILOCK [®] GFS Mini, Loop: 35mm, Button L: 12mm, W: 3.9mm
6-007-07	AUXILOCK [®] GFS Mini, Loop: 40mm, Button L: 12mm, W: 3.9mm
6-007-08	AUXILOCK [®] GFS Mini, Loop: 45mm, Button L: 12mm, W: 3.9mm
6-007-09	AUXILOCK [®] GFS Mini, Loop: 50mm, Button L: 12mm, W: 3.9mm
6-007-10	AUXILOCK [®] GFS Mini, Loop: 55mm, Button L: 12mm, W: 3.9mm

Recommended Instrumentation

Code	Product Description	Compatible Implants
7-013-57	Ø4.5mm Cannulated Headed Reamer	6-007-01, 6-007-02, 6-007-03, 6-007-04, 6-007-05 6-007-06, 6-007-07, 6-007-08, 6-007-09, 6-007-10

STERILE EO

AUXILOCK[®] GFS II LARGE

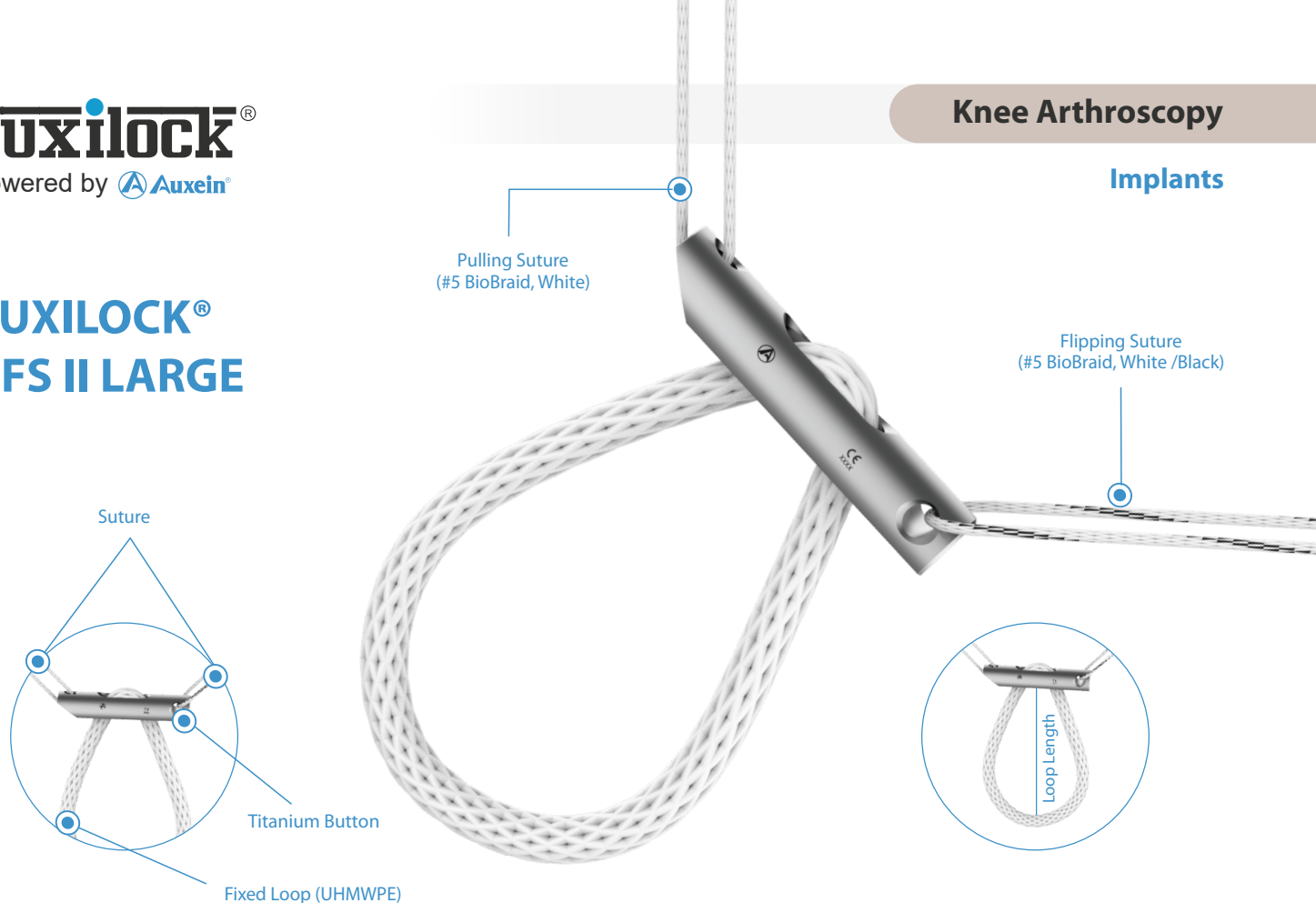

GFS II Large is a fixed loop with an oblong shaped button used for Graft Fixations in ACL/PCL Reconstruction. Being a continuous loop without any joint, GFS II Large provides a stronger fixation and also eliminates the need for knot tying. The GFS II Large includes a larger button compared to GFS Mini which eliminates the need for a stepped tunnel technique. Hence, GFS II Large is considered as an excellent choice for revision surgeries. The pre-loaded pulling and Flipping braided sutures are available to ensure controlled pulling and flipping of the button in the transosseous tunnel. GFS II Large is available in various pre-measured loop sizes. The fixed loop is made up of UHMWPE (Ultra High Molecular Weight Polyethylene) while the oblong button is made up of titanium material.

- Pulling Suture (#5, White) : It is available to pull the graft inside the tunnel.
- Flipping Suture (#5, White/Black) : It ensures the flipping of the button.

Ordering Information

Code	Product Description
6-008-01	AUXILOCK [®] GFS II Large, Loop: 12mm, Button L: 16.5mm, W: 4.4mm
6-008-02	AUXILOCK [®] GFS II Large, Loop: 15mm, Button L: 16.5mm, W: 4.4mm
6-008-03	AUXILOCK [®] GFS II Large, Loop: 20mm, Button L: 16.5mm, W: 4.4mm
6-008-04	AUXILOCK [®] GFS II Large, Loop: 25mm, Button L: 16.5mm, W: 4.4mm
6-008-05	AUXILOCK [®] GFS II Large, Loop: 30mm, Button L: 16.5mm, W: 4.4mm
6-008-06	AUXILOCK [®] GFS II Large, Loop: 35mm, Button L: 16.5mm, W: 4.4mm
6-008-07	AUXILOCK [®] GFS II Large, Loop: 40mm, Button L: 16.5mm, W: 4.4mm
6-008-08	AUXILOCK [®] GFS II Large, Loop: 45mm, Button L: 16.5mm, W: 4.4mm
6-008-10	AUXILOCK [®] GFS II Large, Loop: 50mm, Button L: 16.5mm, W: 4.4mm
6-008-11	AUXILOCK [®] GFS II Large, Loop: 55mm, Button L: 16.5mm, W: 4.4mm

Recommended Instrumentation

Code	Product Description	Compatible Implants
7-014-06	Cannulated Headed Reamer, Ø4.7mm	6-008-01, 6-008-02, 6-008-03, 6-008-04, 6-008-05, 6-008-06, 6-008-07, 6-008-08, 6-008-09, 6-008-10, 6-008-11

STERILE EO

AUXILOCK[®] NAKED BUTTON



GFS Mini Naked Button



GFS II Large Naked Button



Ultimate Mini Naked Button



Ultimate Large Naked Button

GFS Naked button is made up of titanium alloy. The system provides an excellent combination of strength and stiffness required for successful cortical fixation. The large naked buttons of GFS may eliminate the need for a stepped tunnel technique and are considered to be an excellent choice for revision surgeries.

Ordering Information

Code	Product Description	Length	Width	Height
6-007-11	AUXILOCK [®] GFS Mini Naked Button L: 12mm, W: 3.9mm	12mm	3.9mm	1.5mm
6-008-09	AUXILOCK [®] GFS II Large Naked Button L: 16.5mm, W: 4.4mm	16.5mm	4.4mm	2.8mm
6-006-03	AUXILOCK [®] Ultimate Mini Naked Button L: 12mm, W: 3.9mm	12mm	3.9mm	1.5mm
6-006-04	AUXILOCK [®] Ultimate Large Naked Button L: 16.5mm, W: 3.9mm	16.5mm	3.9mm	1.5mm

STERILE EO

AUXILOCK[®] GFS CONCAVE BUTTON



The GFS Concave Button is an attachable Button System that has revolutionized tibial fixation of ACL and PCL grafts. GFS Concave Button can be used on all graft types and attached to a variety of button configurations for fixation over sockets or full tunnels.

The advantages of the GFS Concave Button implant include:

- Maximum graft-to-bone contact improves incorporation and healing
- The ability to retension grafts after fixation and knee cycling
- Several different button options for sockets and full tunnels

Ordering Information

Code	Product Description
6-050-01	AUXILOCK [®] GFS Concave Button 11mm with 4mm Collar
6-050-02	AUXILOCK [®] GFS Concave Button 14mm with 7mm Collar
6-050-03	AUXILOCK [®] GFS Concave Button 20mm with 9mm Collar
6-050-04	AUXILOCK [®] GFS Round Button without Collar, 14mm



Concave Button 20mm
with 9mm Collar

Use with 9 mm-13 mm
tunnels



Concave Button 14mm
with 7mm Collar

Use with 7 mm-9 mm
tunnels



Concave Button
11mm with 4mm Collar

Use with 4 mm-7 mm
tunnels



Round Button without
Collar, 14mm

STERILE EO

**AUXILOCK[®]
GFS BUTTON
EXTENDER**

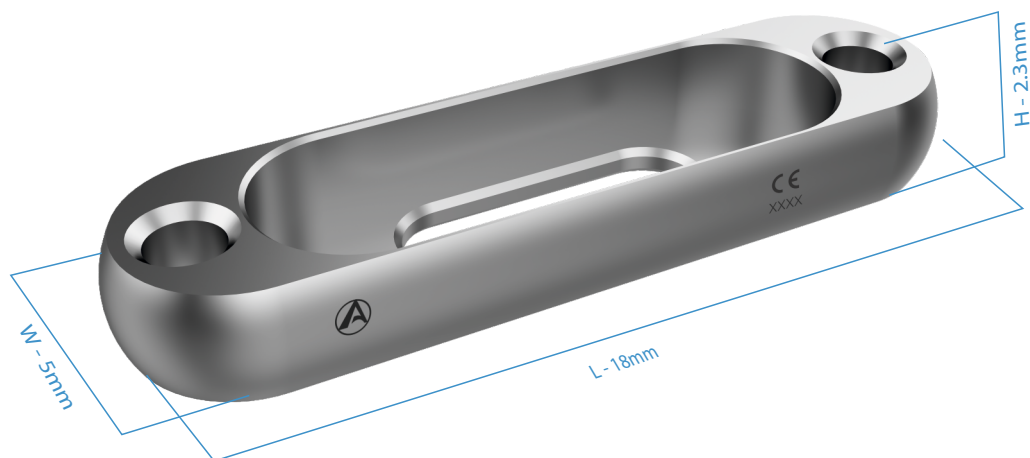

Holes to accommodate Pulling & Flipping Sutures

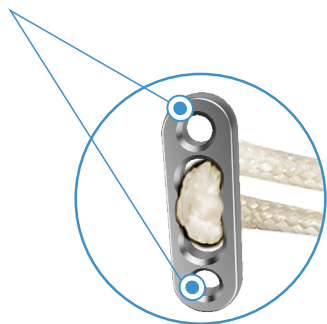

GFS Mini Button & GFS Ultimate Mini Button

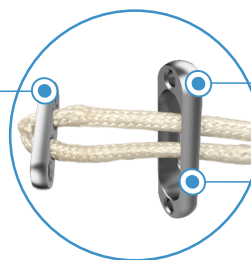

Button Extender

Slotted Design

GFS Button Extender is an extension device designed to provide extended surface area during cruciate graft reconstructions. It can be used in conjunction with the GFS Mini and GFS Ultimate Mini button providing an effective solution for cortical blowouts. It also helps overcome intraoperative complications seen in revision surgeries.

Ordering Information

Code	Product Description	Length	Width	Height	Slot Depth
6-032-01	AUXILOCK [®] GFS Button Extender, L: 18mm, W: 5.0mm	18mm	5mm	2.3mm	1.7mm

STERILE EO

AUXILOCK[®] PEEK CF INTERFERENCE SCREW

The PEEK CF Interference Screw is made of A carbon fiber reinforced PEEK OPTIMA from Invivo, USA. The polymer in PEEK CF enhances the physical strength by nearly twice as much as natural PEEK. Its mechanical properties are much closer to the cortical bone than the natural PEEK, PLLA or Titanium. The PEEK CF Interference Screw has a fully threaded design that provides strong mechanical fixation for both bone tendon bone (BTB) and soft tissue grafts. It is renowned for its radiolucent properties, less imaging artifact and for being MRI safe. PEEK CF interference screw offers the revision ability of an absorbable screw.



Ordering Information

Code	Product Description
6-009-01	AUXILOCK [®] 7mm x 20mm PEEK CF Interference Screw
6-009-02	AUXILOCK [®] 7mm x 25mm PEEK CF Interference Screw
6-009-03	AUXILOCK [®] 7mm x 30mm PEEK CF Interference Screw
6-009-04	AUXILOCK [®] 8mm x 20mm PEEK CF Interference Screw
6-009-05	AUXILOCK [®] 8mm x 25mm PEEK CF Interference Screw
6-009-06	AUXILOCK [®] 8mm x 30mm PEEK CF Interference Screw
6-009-07	AUXILOCK [®] 8mm x 35mm PEEK CF Interference Screw
6-009-08	AUXILOCK [®] 9mm x 20mm PEEK CF Interference Screw
6-009-09	AUXILOCK [®] 9mm x 25mm PEEK CF Interference Screw
6-009-10	AUXILOCK [®] 9mm x 30mm PEEK CF Interference Screw
6-009-11	AUXILOCK [®] 9mm x 35mm PEEK CF Interference Screw
6-009-12	AUXILOCK [®] 10mm x 25mm PEEK CF Interference Screw
6-009-13	AUXILOCK [®] 10mm x 30mm PEEK CF Interference Screw
6-009-14	AUXILOCK [®] 10mm x 35mm PEEK CF Interference Screw
6-009-15	AUXILOCK [®] 11mm x 25mm PEEK CF Interference Screw
6-009-16	AUXILOCK [®] 11mm x 30mm PEEK CF Interference Screw
6-009-17	AUXILOCK [®] 11mm x 35mm PEEK CF Interference Screw
6-009-18	AUXILOCK [®] 12mm x 25mm PEEK CF Interference Screw
6-009-19	AUXILOCK [®] 12mm x 30mm PEEK CF Interference Screw
6-009-20	AUXILOCK [®] 12mm x 35mm PEEK CF Interference Screw

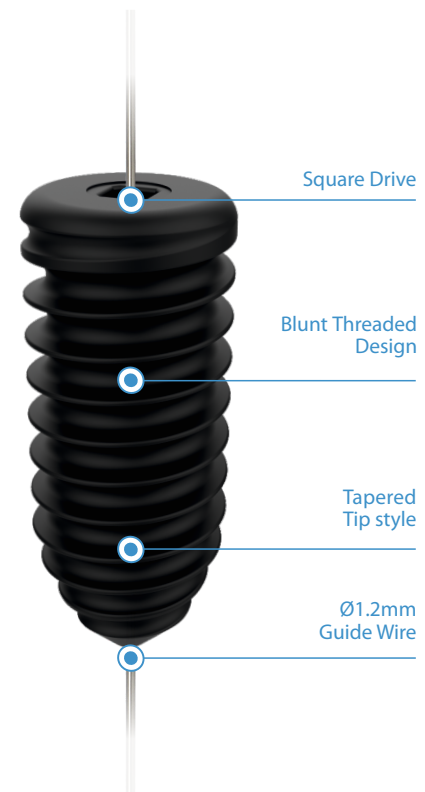

Recommended Instrumentation

Code	Product Description	Compatible Implants
7-014-43	Nitinol Guide Wire Ø1.2mm x Length 300mm (For Interference Screws)	6-009-01, 6-009-02, 6-009-03, 6-009-04, 6-009-05, 6-009-06, 6-009-07, 6-009-08, 6-009-09, 6-009-10, 6-009-11, 6-009-12, 6-009-13, 6-009-14, 6-009-15, 6-009-16, 6-009-17, 6-009-18, 6-009-19, 6-009-20
7-014-04	Screwdriver For Polymer Interference Screw	
7-014-96	Screwdriver Shaft For Polymer Interference Screw, Hudson Coupling	
7-014-42	Ratchet Handle For Hudson Coupling Screwdriver Shaft	

STERILE EO

AUXILOCK[®] PEEK OPTIMA INTERFERENCE SCREW

The PEEK OPTIMA (From Invibio, USA) interference screw is made up of PEEK (Poly-Ether-Ether-Ketone). PEEK is a thermoplastic material and has radiolucent properties for easy artifact free monitoring and assessment of the healing site with X-ray, CT or MRI. It also offers the revision ability of an absorbable screw. PEEK OPTIMA Interference Screw has a fully threaded design. It provides strong mechanical fixation for both Bone-Tendon-Bone (BTB) and soft tissue grafts. PEEK OPTIMA is considered to be extremely strong, durable, and highly resistant to creep & fatigue. The bone-like modulus help minimize stress shielding and also stimulates bone healing.

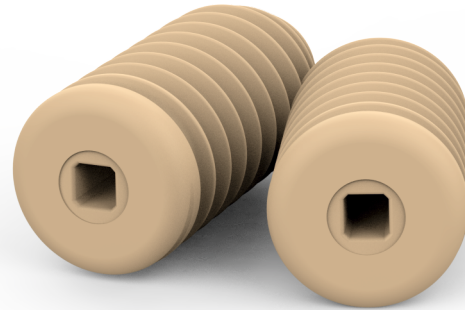

Ordering Information

Code	Product Description
6-014-01	AUXILOCK [®] 7mm x 20mm PEEK OPTIMA Interference Screw
6-014-02	AUXILOCK [®] 7mm x 25mm PEEK OPTIMA Interference Screw
6-014-03	AUXILOCK [®] 7mm x 30mm PEEK OPTIMA Interference Screw
6-014-04	AUXILOCK [®] 8mm x 20mm PEEK OPTIMA Interference Screw
6-014-05	AUXILOCK [®] 8mm x 25mm PEEK OPTIMA Interference Screw
6-014-06	AUXILOCK [®] 8mm x 30mm PEEK OPTIMA Interference Screw
6-014-07	AUXILOCK [®] 8mm x 35mm PEEK OPTIMA Interference Screw
6-014-08	AUXILOCK [®] 9mm x 20mm PEEK OPTIMA Interference Screw
6-014-09	AUXILOCK [®] 9mm x 25mm PEEK OPTIMA Interference Screw
6-014-10	AUXILOCK [®] 9mm x 30mm PEEK OPTIMA Interference Screw
6-014-11	AUXILOCK [®] 9mm x 35mm PEEK OPTIMA Interference Screw
6-014-12	AUXILOCK [®] 10mm x 25mm PEEK OPTIMA Interference Screw
6-014-13	AUXILOCK [®] 10mm x 30mm PEEK OPTIMA Interference Screw
6-014-14	AUXILOCK [®] 10mm x 35mm PEEK OPTIMA Interference Screw
6-014-15	AUXILOCK [®] 11mm x 25mm PEEK OPTIMA Interference Screw
6-014-16	AUXILOCK [®] 11mm x 30mm PEEK OPTIMA Interference Screw
6-014-17	AUXILOCK [®] 11mm x 35mm PEEK OPTIMA Interference Screw
6-014-18	AUXILOCK [®] 12mm x 25mm PEEK OPTIMA Interference Screw
6-014-19	AUXILOCK [®] 12mm x 30mm PEEK OPTIMA Interference Screw
6-014-20	AUXILOCK [®] 12mm x 35mm PEEK OPTIMA Interference Screw

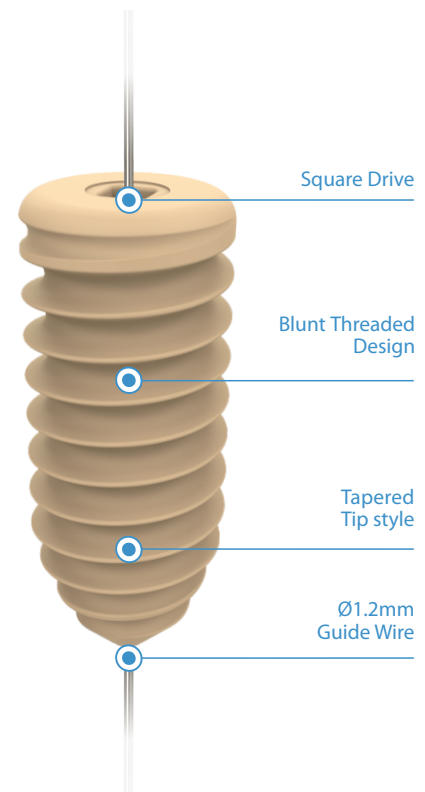

Recommended Instrumentation

Code	Product Description	Compatible Implants
7-014-43	Nitinol Guide Wire Ø1.2mm x Length 300mm (For Interference Screws)	6-014-01, 6-014-02, 6-014-03, 6-014-04, 6-014-05, 6-014-06, 6-014-07, 6-014-08, 6-014-09, 6-014-10, 6-014-11, 6-014-12, 6-014-13, 6-014-14, 6-014-15, 6-014-16, 6-014-17, 6-014-18, 6-014-19, 6-014-20
7-014-04	Screwdriver For Polymer Interference Screw	
7-014-96	Screwdriver Shaft For Polymer Interference Screw, Hudson Coupling	
7-014-42	Ratchet Handle For Hudson Coupling Screwdriver Shaft	

STERILE EO

AUXILOCK[®] TITANIUM INTERFERENCE SCREW

The Titanium interference screw is made up of Titanium alloy. The screw has a fully threaded design which provides strong mechanical fixation for both Bone-Tendon-Bone (BTB) and soft tissue grafts. The rounded edge of the threads protects tissue grafts. Titanium Interference Screw is a cannulated screw to be used with guide wire and cannulated screw driver.



Ordering Information

Code	Product Description
6-010-01	AUXILOCK [®] 7mm x 20mm Titanium Interference Screw
6-010-02	AUXILOCK [®] 7mm x 25mm Titanium Interference Screw
6-010-03	AUXILOCK [®] 7mm x 30mm Titanium Interference Screw
6-010-04	AUXILOCK [®] 7mm x 35mm Titanium Interference Screw
6-010-05	AUXILOCK [®] 8mm x 20mm Titanium Interference Screw
6-010-06	AUXILOCK [®] 8mm x 25mm Titanium Interference Screw
6-010-07	AUXILOCK [®] 8mm x 30mm Titanium Interference Screw
6-010-08	AUXILOCK [®] 8mm x 35mm Titanium Interference Screw
6-010-09	AUXILOCK [®] 9mm x 20mm Titanium Interference Screw
6-010-10	AUXILOCK [®] 9mm x 25mm Titanium Interference Screw
6-010-11	AUXILOCK [®] 9mm x 30mm Titanium Interference Screw
6-010-12	AUXILOCK [®] 9mm x 35mm Titanium Interference Screw
6-010-13	AUXILOCK [®] 10mm x 25mm Titanium Interference Screw
6-010-14	AUXILOCK [®] 10mm x 30mm Titanium Interference Screw
6-010-15	AUXILOCK [®] 10mm x 35mm Titanium Interference Screw
6-010-16	AUXILOCK [®] 11mm x 25mm Titanium Interference Screw
6-010-17	AUXILOCK [®] 11mm x 30mm Titanium Interference Screw
6-010-18	AUXILOCK [®] 11mm x 35mm Titanium Interference Screw
6-010-19	AUXILOCK [®] 12mm x 25mm Titanium Interference Screw
6-010-20	AUXILOCK [®] 12mm x 30mm Titanium Interference Screw
6-010-21	AUXILOCK [®] 12mm x 35mm Titanium Interference Screw

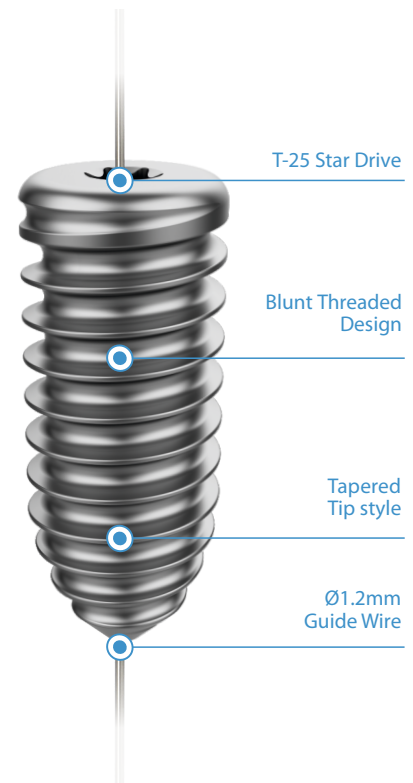

Recommended Instrumentation

Code	Product Description	Compatible Implants
7-014-43	Nitinol Guide Wire Ø1.2mm x Length 300mm (For Interference Screws)	6-010-01, 6-010-02, 6-010-03, 6-010-04, 6-010-05, 6-010-06, 6-010-07, 6-010-08, 6-010-09, 6-010-10, 6-010-11, 6-010-12, 6-010-13, 6-010-14, 6-010-15, 6-010-16, 6-010-17, 6-010-18, 6-010-19, 6-010-20, 6-010-21
7-014-05	Screwdriver For Ti Interference Screw, T25 Star Driver	
7-014-95	Screwdriver Shaft For Titanium Interference Screw, T25 Star Driver, Hudson Coupling	
7-014-42	Ratchet Handle For Hudson Coupling Screwdriver Shaft	

STERILE EO

LIGAMENT STAPLE

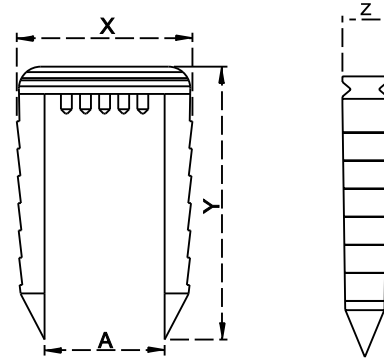
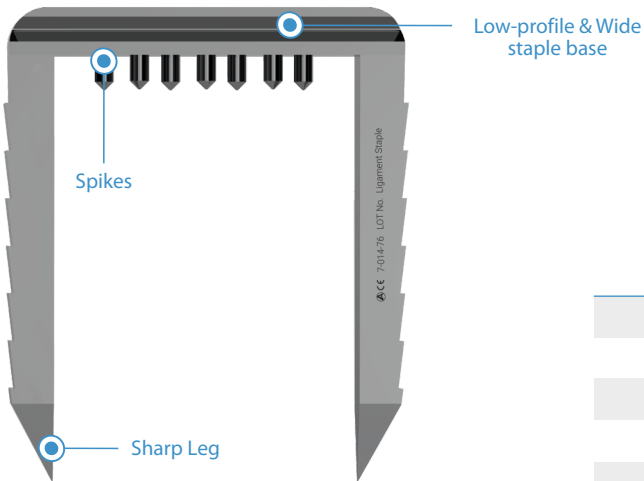

A	X	Y	Z
6mm	11mm	25mm	3.7mm
8mm	13mm	20mm	3.7mm
8mm	13mm	25mm	3.7mm
11mm	16mm	25mm	3.7mm
16mm	21mm	25mm	3.7mm

The Ligament staple is made up of titanium alloy. It can be used for attaching soft tissue to the bone. Low-profile, wide staple base provides better load distribution while impacting. Spike-post leg design encourages uninterrupted vascular flow to the underlying tissue. Sharp leg points for easier penetration into cortical bone. The ligament staples are available in different sizes. The staple impactor is provided in the instrument set for the staple holding and easier staple insertion into the bone.

Ordering Information

Code	Product Description
464-6-11-25	Ligament Staple, 6mm x 11mm x 25mm, Titanium
464-8-13-20	Ligament Staple, 8mm x 13mm x 20mm, Titanium
464-8-13-25	Ligament Staple, 8mm x 13mm x 25mm, Titanium
464-11-16-25	Ligament Staple, 11mm x 16mm x 25mm, Titanium
464-16-21-25	Ligament Staple, 16mm x 21mm x 25mm, Titanium

Recommended Instrumentation

Code	Product Description	Compatible Implants
7-014-76	Staple Impactor	464-8-13-20, 464-6-11-25, 464-8-13-25, 464-11-16-25, 464-16-21-25

STERILE EO

AUXILOCK[®] MENISCO INSIDE-OUT

Menisco Inside-out system is specifically designed for inside-out meniscal repair procedures features cannulas, needles and rasps.

Five pre-bent Single Lumen cannulas provide optimum access to all zones of the meniscus with funnel ends that make the loading of needles safe and easy.

Double-arm meniscal repair needles are thin, strong and flexible for easy passage. The needles are available with Pre-attached #2-0, #0 BioBraid Suture & 1.0mm Suture Tape. Meniscal repair needles are made of Stainless Steel and have a large eyelet at one end to permit easy threading of suture material.

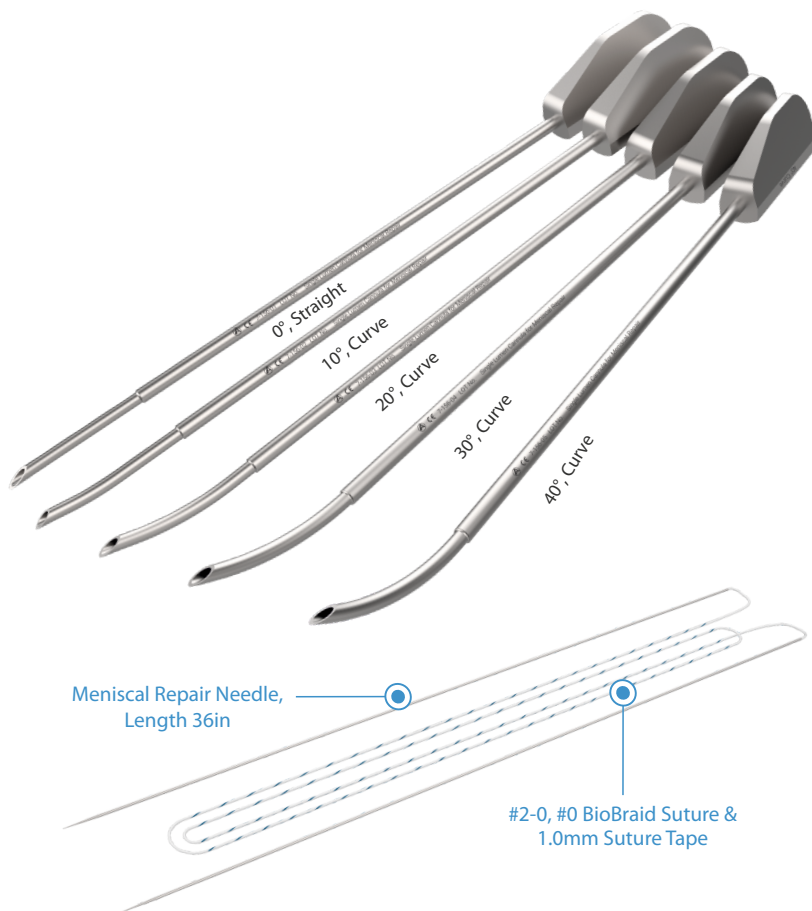

Ordering Information

Code	Product Description
6-047-01	AUXILOCK [®] MENISCO Inside-Out Meniscal Repair Needle with #2-0 BioBraid: White/Blue, Length 36in, Needle Length 25cm
6-047-02	AUXILOCK [®] MENISCO Inside-Out Meniscal Repair Needle with #0 BioBraid: White/Blue, Length 36in, Needle Length 25cm
6-047-03	AUXILOCK [®] MENISCO Inside-Out Meniscal Repair Needle with 1.0mm Suture Tape: White/Blue, Length 36in, Needle Length 25cm

Related Instrumentation

Code	Product Description
7-156-01	Single Lumen Cannula for Meniscal Repair, Straight
7-156-02	Single Lumen Cannula for Meniscal Repair, 10° Curve
7-156-03	Single Lumen Cannula for Meniscal Repair, 20° Curve
7-156-04	Single Lumen Cannula for Meniscal Repair, 30° Curve
7-156-05	Single Lumen Cannula for Meniscal Repair, 40° Curve
7-156-06	Bender for Cannula
7-156-07	Needle Pusher
7-156-08	Slotted Cannula
7-156-09	Knot Pusher for Meniscal Repair
7-156-10	Curved Probe for Meniscal Repair
7-156-11	Diamond Rasp, 45° for Meniscal Repair
7-156-12	Diamond Rasp, 90° for Meniscal Repair
7-156-13	Ring Curette for Meniscal Repair
7-156-14	Knot Pusher with Suture Cutter for Meniscal Repair

STERILE EO

AUXILOCK[®] MENI-FIX ALL INSIDE

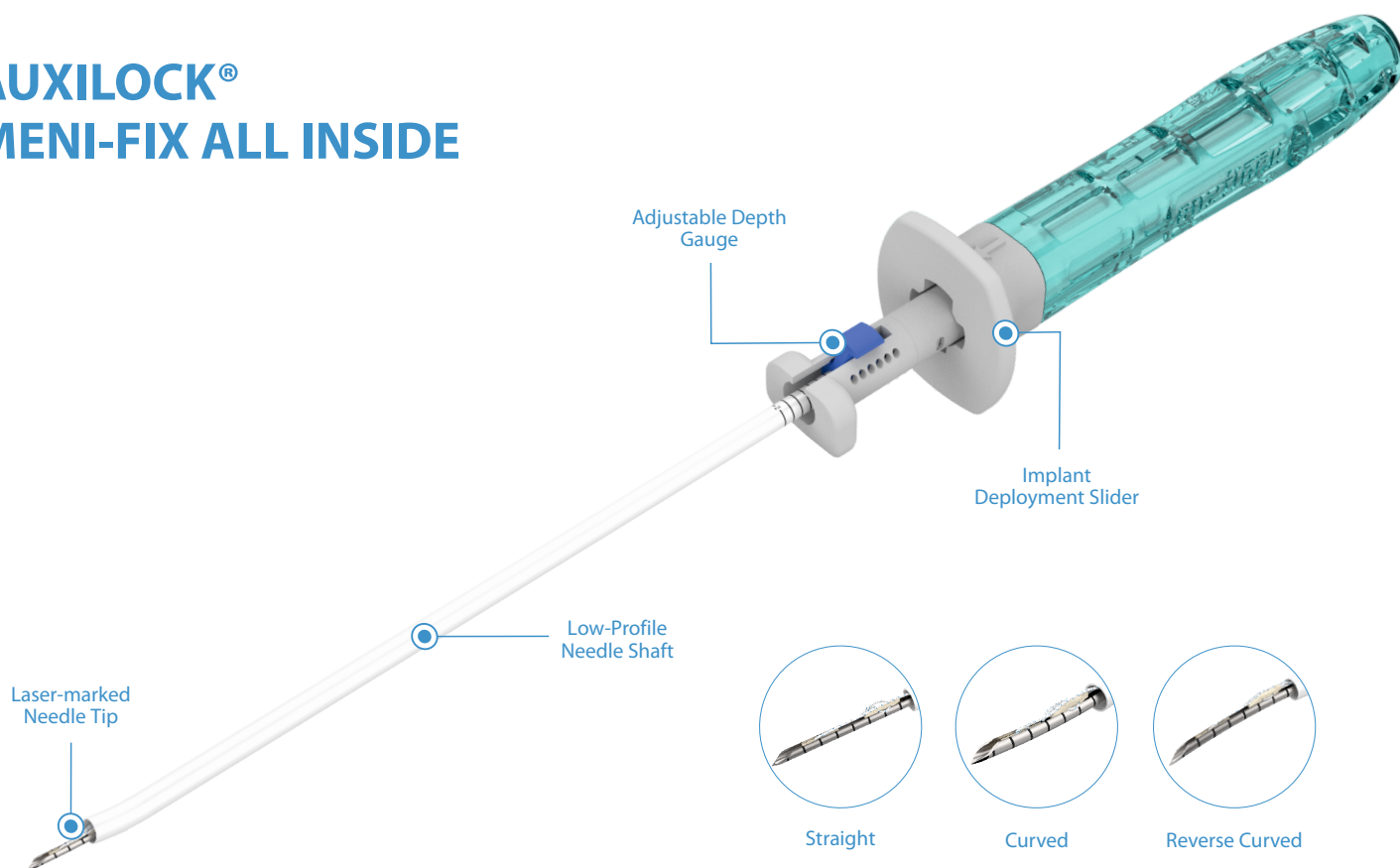

MENI-FIX All-Inside Meniscal Repair System includes two 0.9mm PEEK anchors with a pretied, self-sliding knot comprised of #2-0, UHMWPE Biobraid Suture.

The delivery needles are available in Curved, Straight, and Reverse Curved designs. The Curved and Reverse Curved designs allow the surgeon to rotate the needle tip away from the neurovascular structures when penetrating the meniscus, further reducing the risk of neurovascular injury. The Curved delivery needle is optimally shaped to allow vertical mattress sutures to be inserted on either the femoral or tibial surfaces of the meniscus.

The Reverse Curved delivery needle is most useful for repairing tears on the tibial surface and more anterior located tears. The built-in, adjustable depth penetration limiter is adjustable from 8mm to 18mm from the tip of the needle. Use of the meniscal depth probe in conjunction with the adjustable depth penetration limiter allows controlled delivery of the implants.

Ordering Information

Code	Product Description
6-048-01	AUXILOCK [®] MENI-FIX All-Inside Meniscal Repair System - Straight Needle
6-048-02	AUXILOCK [®] MENI-FIX All-Inside Meniscal Repair System - Curve Needle
6-048-03	AUXILOCK [®] MENI-FIX All-Inside Meniscal Repair System - Reverse Curve Needle

Related Instrumentation

Code	Product Description
7-156-08	Slotted Cannula
7-156-14	Knot Pusher with Suture Cutter for Meniscal Repair

STERILE EO

7-014-01
Transportal Femoral Offset Guide, 5mm



7-014-02
Transportal Femoral Offset Guide, 6mm



7-014-03
Transportal Femoral Offset Guide, 7mm



Transtibial Femoral Offset Guide

Code	Diameter
7-014-45	5mm
7-014-46	6mm
7-014-47	7mm

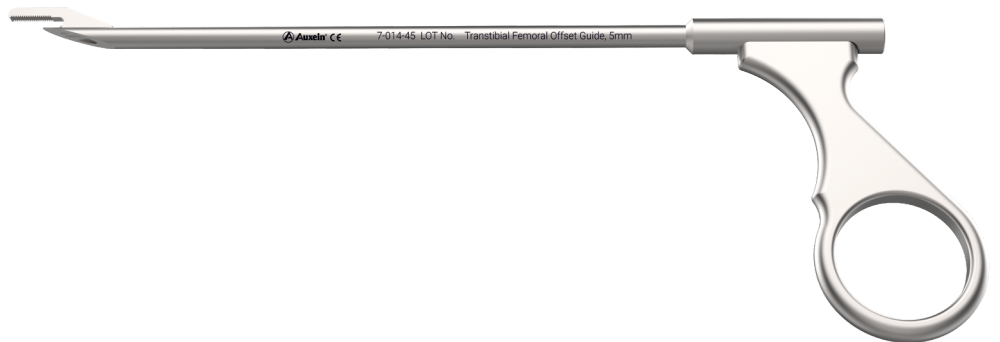

7-014-04
Screwdriver For Polymer Interference Screw



7-014-05
Screwdriver For Ti Interference Screw, T25 Star Driver



7-013-57

Ø4.5mm Cannulated Headed Reamer



7-014-06

Cannulated Headed Reamer, Ø4.7mm



Tibial Cannulated Reamer

Code	Diameter
7-014-07	Ø6mm
7-014-08	Ø6.5mm
7-014-09	Ø7mm
7-014-10	Ø7.5mm
7-014-11	Ø8mm

Code	Diameter
7-014-12	Ø8.5mm
7-014-13	Ø9mm
7-014-14	Ø9.5mm
7-014-15	Ø10mm

Code	Diameter
7-014-16	Ø10.5mm
7-014-17	Ø11mm
7-014-18	Ø11.5mm
7-014-19	Ø12mm

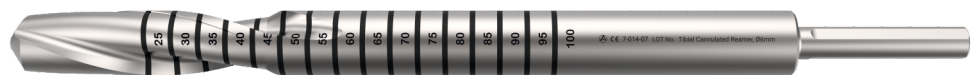

Femoral Cannulated Reamer

Code	Diameter
7-014-20	Ø6mm
7-014-21	Ø6.5mm
7-014-22	Ø7mm
7-014-23	Ø7.5mm
7-014-24	Ø8mm

Code	Diameter
7-014-25	Ø8.5mm
7-014-26	Ø9mm
7-014-27	Ø9.5mm
7-014-28	Ø10mm

Code	Diameter
7-014-29	Ø10.5mm
7-014-30	Ø11mm
7-014-31	Ø11.5mm
7-014-32	Ø12mm



Instruments

7-014-33
Drill Guide Handle



7-014-34
PCL Tibial Aimer With O Tip

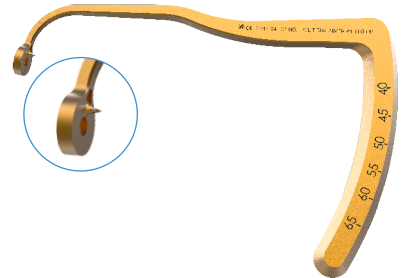

7-014-35
ACL Tip C Aimer, Right

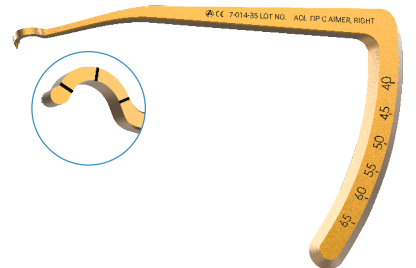

7-014-36
ACL Tip C Aimer, Left

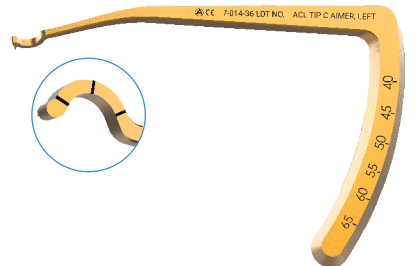

7-014-37
ACL Tip O Aimer

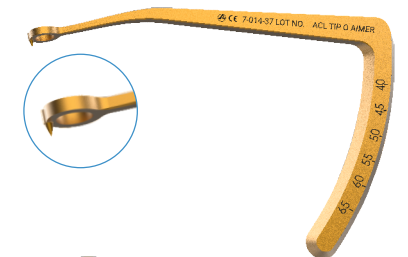

7-014-38
ACL Tip Aimer

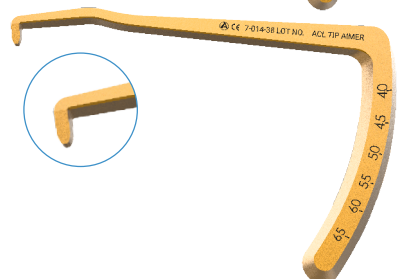

7-014-40
PCL Tibial Aimer With C Tip

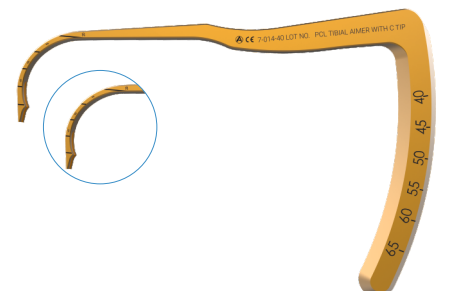

7-014-41
PCL Femoral Aimer

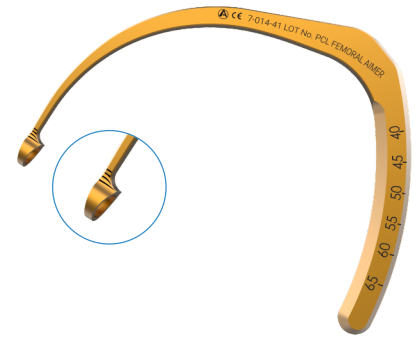

7-014-99
ACL Elbow Aimer

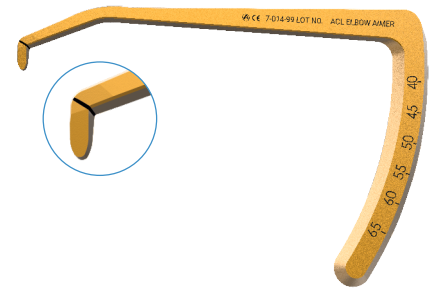

7-014-39
2.4mm Drill Guide Bullet

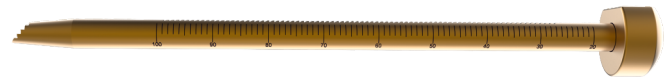

7-014-97
4.5mm FlyKuter Guide Bullet



7-014-43
Nitinol Guide Wire Ø1.2mm x Length 300mm (For Interference Screws)

7-014-44
Depth Gauge For Knee ACL/PCL Instrument



7-014-48
Tendon Stripper (Closed End), Ø6mm



7-014-49
Tendon Stripper (Closed End), Ø7mm



7-014-50
Tendon Stripper (Closed End), Ø8mm



7-014-51
Tendon Stripper (Open End), Ø6mm



7-014-52
Tendon Stripper (Open End), Ø7mm



7-014-53
Tendon Stripper (Open End), Ø8mm



7-014-54
Graft Sizer, 6mm to 12mm (0.5mm steps)



7-014-55
Quick Coupling T-Handle For Tunnel Dilator



Tunnel Dilator, Cannulated

Code	Diameter
7-014-56	Ø6mm
7-014-57	Ø7mm
7-014-58	Ø8mm
7-014-59	Ø9mm
7-014-60	Ø10mm



7-014-61
Straight Rasp



7-014-62
Convex Rasp

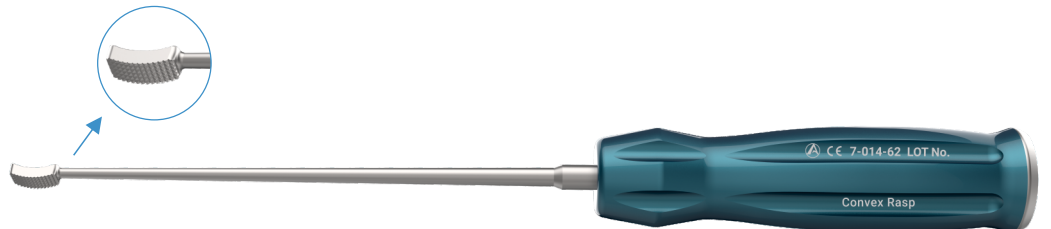

7-014-63
Half-Round Rasp

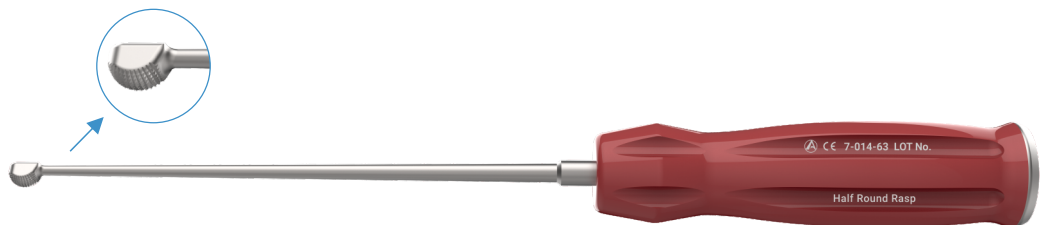

7-014-64
Curette, 25° Angled Down



7-014-65
Arthroscopic Probe - Knee



7-014-66
Pin, Trocar-Tip, Ø2.4mm X 355mm



7-014-67
Pin, Drill Tip, Ø2.4mm x 355mm



7-014-68
Passing Pin, Ø2.4mm x 250mm



7-014-69
Micro Fracture Awl, 0°



7-014-70
Micro Fracture Awl, 25°



7-014-71
Micro Fracture Awl, 40°



7-014-72
Micro Fracture Awl, 60°



7-017-01
Graft Station Board

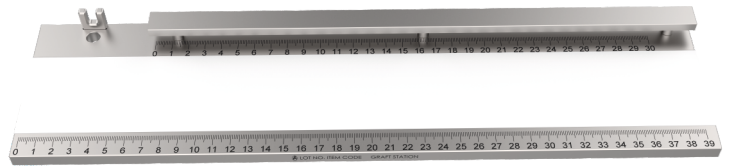

7-017-02
Sliding Base

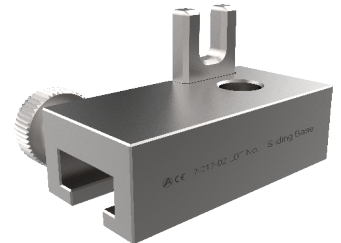

7-017-03
Graft Grasper Clamp - Left



7-017-04
Graft Grasper Clamp - Right

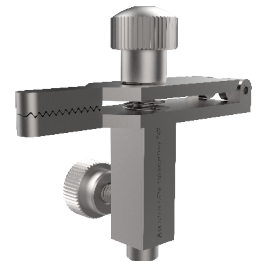

7-017-05
Button Holder With Scale

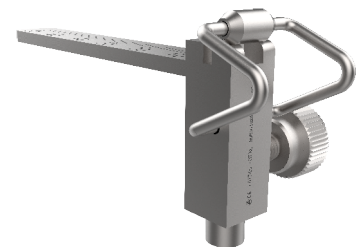

7-017-06
Suture Holder With Tensioner

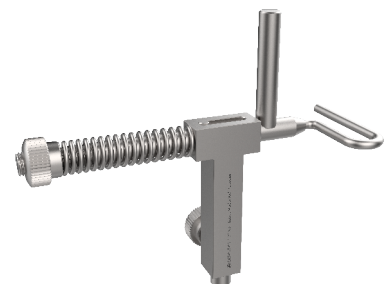

Tunnel Plug

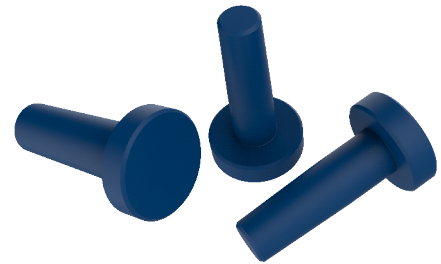

Code	Dia
7-014-73	7-8mm
7-014-74	8-9mm
7-014-75	9-10mm

7-014-76
Staple Impactor

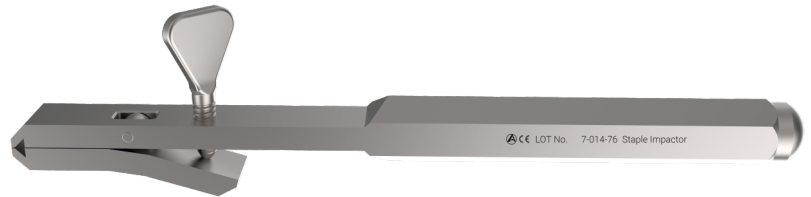

7-014-77
PCL Elevator With Wire Capture Hole

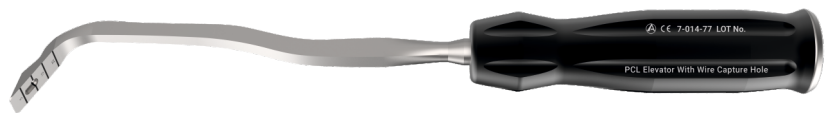

7-014-42
Ratchet Handle For Hudson Coupling Screwdriver Shaft



7-014-95
Screwdriver Shaft For Titanium Interference Screw, T25 Star Driver, Hudson Coupling



7-014-96
Screwdriver Shaft For Polymer Interference Screw, Hudson Coupling



OPTIONAL INSTRUMENTATION

Auxilock FlyKuter, Type-I

Code	Product Description	Unit
7-014-83	Auxilock FlyKuter Ø6.5mm, Type-I	1
7-014-84	Auxilock FlyKuter Ø7mm, Type-I	1
7-014-85	Auxilock FlyKuter Ø7.5mm, Type-I	1
7-014-86	Auxilock FlyKuter Ø8mm, Type-I	1
7-014-87	Auxilock FlyKuter Ø8.5mm, Type-I	1
7-014-88	Auxilock FlyKuter Ø9mm, Type-I	1
7-014-89	Auxilock FlyKuter Ø9.5mm, Type-I	1
7-014-90	Auxilock FlyKuter Ø10mm, Type-I	1
7-014-91	Auxilock FlyKuter Ø10.5mm, Type-I	1
7-014-92	Auxilock FlyKuter Ø11mm, Type-I	1
7-014-93	Auxilock FlyKuter Ø11.5mm, Type-I	1
7-014-94	Auxilock FlyKuter Ø12mm, Type-I	1



6-029

Flexible Cannulated Reamer Set

Code	Product Description	Unit
6-029-01	Flexible Cannulated Reamer Ø4.7mm for Knee ACL System	1
6-029-02	Flexible Cannulated Reamer Ø5.0mm for Knee ACL System	1
6-029-03	Flexible Cannulated Reamer Ø5.5mm for Knee ACL System	1
6-029-04	Flexible Cannulated Reamer Ø6.0mm for Knee ACL System	1
6-029-05	Flexible Cannulated Reamer Ø6.5mm for Knee ACL System	1
6-029-06	Flexible Cannulated Reamer Ø7.0mm for Knee ACL System	1
6-029-07	Flexible Cannulated Reamer Ø7.5mm for Knee ACL System	1
6-029-08	Flexible Cannulated Reamer Ø8.0mm for Knee ACL System	1
6-029-09	Flexible Cannulated Reamer Ø8.5mm for Knee ACL System	1
6-029-10	Flexible Cannulated Reamer Ø9.0mm for Knee ACL System	1
6-029-11	Flexible Cannulated Reamer Ø9.5mm for Knee ACL System	1
6-029-12	Flexible Cannulated Reamer Ø10.0mm for Knee ACL System	1
6-029-13	Flexible Cannulated Reamer Ø10.5mm for Knee ACL System	1
6-029-14	Flexible Cannulated Reamer Ø11.0mm for Knee ACL System	1
6-029-15	Flexible Cannulated Reamer Ø11.5mm for Knee ACL System	1
6-029-16	Flexible Cannulated Reamer Ø12.0mm for Knee ACL System	1
6-029-17	Tray for Flexible Cannulated Reamer Case	1
6-029-18	Case for Flexible Cannulated Reamer	1
6-029-19	Lid For Flexible Cannulated Reamer Case	1



OPTIONAL INSTRUMENTATION

7-148-01
Retro Drill Guide Handle, Side Release

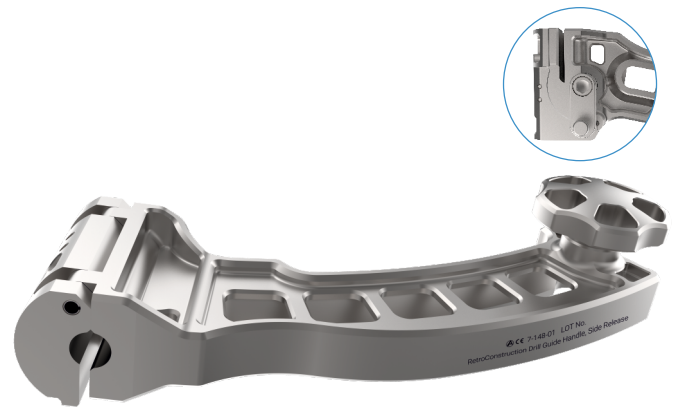

7-148-02
2.4mm Retro Guide Pin Sleeve



7-148-03
4.5mm Retro Drill Sleeve For FlyKuter

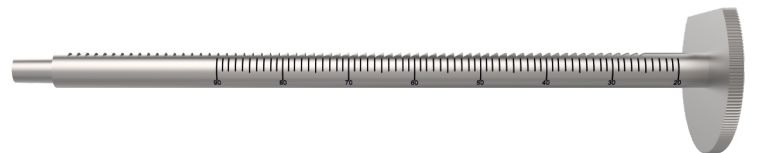

7-148-11
3.5mm Retro Drill Sleeve For Flykuter



7-148-04
Retro Femoral ACL Guide, Right



7-148-05
Retro Femoral ACL Guide, Left



OPTIONAL INSTRUMENTATION

7-148-06
Retro Tibial ACL Marking Hook



7-148-07
Retro PCL Tibial Guide With O Tip

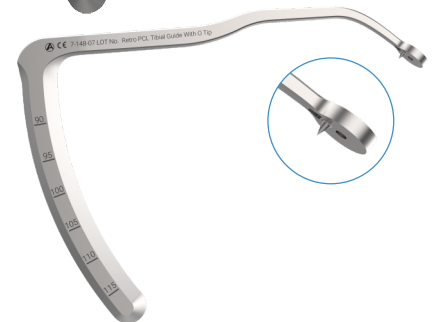

7-148-08
Retro PCL Tibial Guide With C Tip



7-148-09
Retro PCL Femoral Guide

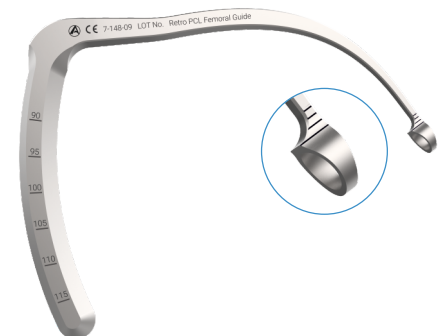

7-148-10
Meniscus Root Marking Hook



OPTIONAL INSTRUMENTATION

7-014-101
Spade Drill Pin, Ø4.5mm X 456mm
Available in **STERILE** **EO**



7-014-102
Tunnel Notcher



7-014-103
PCL Suture Pusher



7-014-104
PCL Rasp, Curved

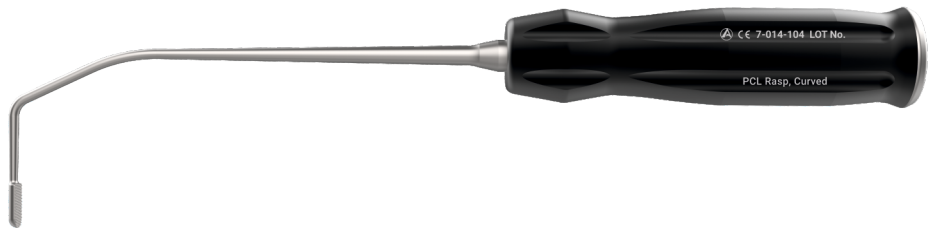

7-014-105
PCL Curved Curette



7-014-107
Straight Curette, Closed End



OPTIONAL INSTRUMENTATION

6-059-01 AUXILOCK[®] ACL Disposable Kit



Instruments include in kit

Code	Product Description	Qty
7-014-67	Passing Pin, Ø2.4mm X 250mm	1
7-014-68	Pin, Drill Tip, Ø2.4mm X355mm	1
7-014-43	Nitinol Guide Wire Ø1.2mm X Length 300mm (For Interference Screws)	1

MENISCO INSIDE-OUT MENISCAL REPAIR SYSTEM INSTRUMENT SET

7-156-01
Single Lumen Cannula for Meniscal Repair, Straight



7-156-02
Single Lumen Cannula for Meniscal Repair, 10° Curve



7-156-03
Single Lumen Cannula for Meniscal Repair, 20° Curve

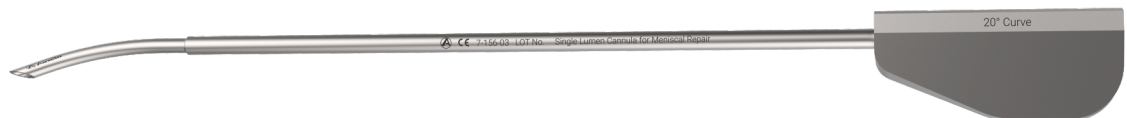

7-156-04
Single Lumen Cannula for Meniscal Repair, 30° Curve

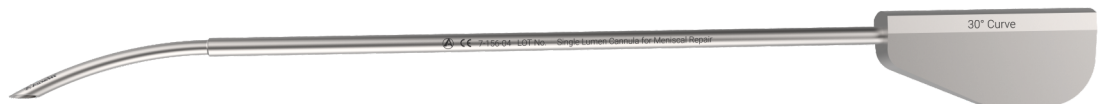

7-156-05
Single Lumen Cannula for Meniscal Repair, 40° Curve



7-156-06
Bender for Cannula

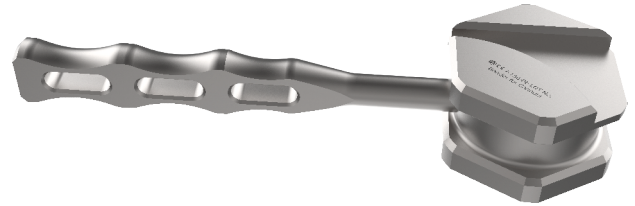

7-156-07
Needle Pusher



7-156-08
Slotted Cannula



7-156-09
Knot Pusher for Meniscal Repair



7-156-10
Curved Probe for Meniscal Repair



7-156-11
Diamond Rasp, 45° for Meniscal Repair



7-156-12
Diamond Rasp, 90° for Meniscal Repair



7-156-13
Ring Curette for Meniscal Repair



OPTIONAL INSTRUMENTATION

7-156-14
Knot Pusher with Suture Cutter for Meniscal Repair
Available in STERILE EO

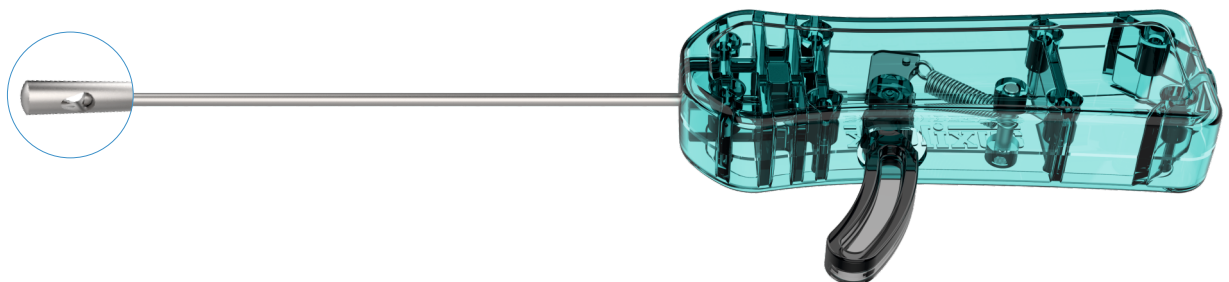

ORDER INFORMATION

7-014 Knee Arthroscopy Instrument Set

Code	Set Consisting of	Unit
7-014-01	Transportal Femoral Offset Guide, 5mm	1
7-014-02	Transportal Femoral Offset Guide, 6mm	1
7-014-03	Transportal Femoral Offset Guide, 7mm	1
7-014-04	Screwdriver For Polymer Interference Screw	1
7-014-05	Screwdriver For Ti Interference Screw, T25 Star Driver	1
7-014-06	Cannulated Headed Reamer, Ø4.7mm	1
7-014-07	Tibial Cannulated Reamer, Ø6mm	1
7-014-08	Tibial Cannulated Reamer, Ø6.5mm	1
7-014-09	Tibial Cannulated Reamer, Ø7mm	1
7-014-10	Tibial Cannulated Reamer, Ø7.5mm	1
7-014-11	Tibial Cannulated Reamer, Ø8mm	1
7-014-12	Tibial Cannulated Reamer, Ø8.5mm	1
7-014-13	Tibial Cannulated Reamer, Ø9mm	1
7-014-14	Tibial Cannulated Reamer, Ø9.5mm	1
7-014-15	Tibial Cannulated Reamer, Ø10mm	1
7-014-16	Tibial Cannulated Reamer, Ø10.5mm	1
7-014-17	Tibial Cannulated Reamer, Ø11mm	1
7-014-18	Tibial Cannulated Reamer, Ø11.5mm	1
7-014-19	Tibial Cannulated Reamer, Ø12mm	1
7-014-20	Femoral Cannulated Reamer, Ø6mm	1
7-014-21	Femoral Cannulated Reamer, Ø6.5mm	1
7-014-22	Femoral Cannulated Reamer, Ø7mm	1
7-014-23	Femoral Cannulated Reamer, Ø7.5mm	1
7-014-24	Femoral Cannulated Reamer, Ø8mm	1
7-014-25	Femoral Cannulated Reamer, Ø8.5mm	1
7-014-26	Femoral Cannulated Reamer, Ø9mm	1
7-014-27	Femoral Cannulated Reamer, Ø9.5mm	1
7-014-28	Femoral Cannulated Reamer, Ø10mm	1
7-014-29	Femoral Cannulated Reamer, Ø10.5mm	1
7-014-30	Femoral Cannulated Reamer, Ø11mm	1
7-014-31	Femoral Cannulated Reamer, Ø11.5mm	1
7-014-32	Femoral Cannulated Reamer, Ø12mm	1
7-014-33	Drill Guide Handle	1
7-014-34	PCL Tibial Aimer With O Tip	1
7-014-35	ACL Tip C Aimer, Right	1
7-014-36	ACL Tip C Aimer, Left	1
7-014-37	ACL Tip O Aimer	1
7-014-38	ACL Tip Aimer	1
7-014-99	ACL Elbow Aimer	1
7-014-39	2.4mm Drill Guide Bullet	1
7-014-40	PCL Tibial Aimer With C Tip	1
7-014-41	PCL Femoral Aimer	1
7-014-43	Nitinol Guide Wire Ø1.2mm x Length 300mm (For Interference Screws)	1
7-014-44	Depth Gauge For Knee ACL/PCL Instrument	1

Code	Set Consisting of	Unit
7-014-45	Transtibial Femoral Offset Guide, 5mm	1
7-014-46	Transtibial Femoral Offset Guide, 6mm	1
7-014-47	Transtibial Femoral Offset Guide, 7mm	1
7-014-48	Tendon Stripper (Closed End), Ø6mm	1
7-014-49	Tendon Stripper (Closed End), Ø7mm	1
7-014-50	Tendon Stripper (Closed End), Ø8mm	1
7-014-51	Tendon Stripper (Open End), Ø6mm	1
7-014-52	Tendon Stripper (Open End), Ø7mm	1
7-014-53	Tendon Stripper (Open End), Ø8mm	1
7-014-54	Graft Sizer, 6mm to 12mm (0.5mm steps)	1
7-014-55	Quick Coupling T-Handle For Tunnel Dilator	1
7-014-56	Tunnel Dilator, Cannulated, Ø6mm	1
7-014-57	Tunnel Dilator, Cannulated, Ø7mm	1
7-014-58	Tunnel Dilator, Cannulated, Ø8mm	1
7-014-59	Tunnel Dilator, Cannulated, Ø9mm	1
7-014-60	Tunnel Dilator, Cannulated, Ø10mm	1
7-014-61	Straight Rasp	1
7-014-62	Convex Rasp	1
7-014-63	Half-Round Rasp	1
7-014-64	Curette, 25° Angled Down	1
7-014-65	Arthroscopic Probe - Knee	1
7-014-66	Pin, Trocar-Tip, Ø2.4mm x 355mm	1
7-014-67	Pin, Drill Tip, Ø2.4mm x 355mm	1
7-014-68	Passing Pin, Ø2.4mm x 250mm	1
7-014-69	Micro Fracture Awl, 0°	1
7-014-70	Micro Fracture Awl, 25°	1
7-014-71	Micro Fracture Awl, 40°	1
7-014-72	Micro Fracture Awl, 60°	1
7-014-73	Tunnel Plug, 7-8mm	1
7-014-74	Tunnel Plug, 8-9mm	1
7-014-75	Tunnel Plug, 9-10mm	1
7-014-76	Staple Impactor	1
7-014-77	PCL Elevator With Wire Capture Hole	1
7-014-42	Ratchet Handle For Hudson Coupling Screwdriver Shaft	1
7-014-95	Screwdriver Shaft For Titanium Interference Screw, T25 Star Driver, Hudson Coupling	1
7-014-96	Screwdriver Shaft For Polymer Interference Screw, Hudson Coupling	1
7-013-57	Ø4.5mm Cannulated Headed Reamer	1
	Instruments Box	
7-014-79	Tray A For Knee Arthroscopy Instruments	1
7-014-80	Tray B For Knee Arthroscopy Instruments	1
7-014-100	Tray C For Knee Arthroscopy Instruments	1
7-014-98	Tray D For Knee Arthroscopy Instruments	1
7-014-81	Container For Knee Arthroscopy Instrument Set	1
7-014-82	Lid For Container, Knee Arthroscopy Instrument Set	1

7-014-79
Tray A For Knee Arthroscopy Instruments

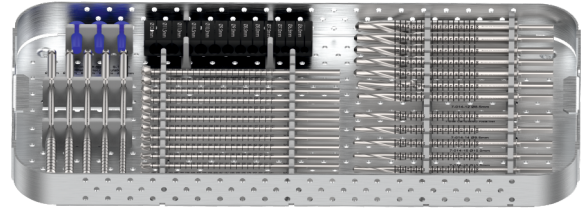

7-014-80
Tray B For Knee Arthroscopy Instruments

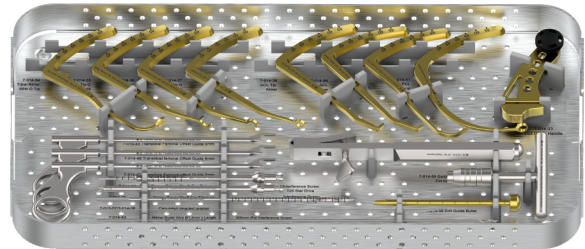

7-014-100
Tray C For Knee Arthroscopy Instruments

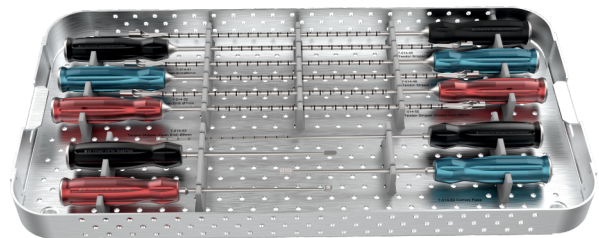

7-014-98
Tray D For Knee Arthroscopy Instruments



7-014C Knee Arthroscopy Instrument Set (Compact)

Code	Set Consisting of	Unit
7-014-01	Transportal Femoral Offset Guide, 5mm	1
7-014-03	Transportal Femoral Offset Guide, 7mm	1
7-014-04	Screwdriver For Polymer Interference Screw	1
7-014-05	Screwdriver For Ti Interference Screw, T25 Star Driver	1
7-013-57	Ø4.5mm Cannulated Headed Reamer	1
7-014-06	Cannulated Headed Reamer, Ø4.7mm	1
7-014-07	Tibial Cannulated Reamer, Ø6mm	1
7-014-09	Tibial Cannulated Reamer, Ø7mm	1
7-014-11	Tibial Cannulated Reamer, Ø8mm	1
7-014-13	Tibial Cannulated Reamer, Ø9mm	1
7-014-15	Tibial Cannulated Reamer, Ø10mm	1
7-014-17	Tibial Cannulated Reamer, Ø11mm	1
7-014-19	Tibial Cannulated Reamer, Ø12mm	1
7-014-20	Femoral Cannulated Reamer, Ø6mm	1
7-014-22	Femoral Cannulated Reamer, Ø7mm	1
7-014-24	Femoral Cannulated Reamer, Ø8mm	1
7-014-26	Femoral Cannulated Reamer, Ø9mm	1
7-014-28	Femoral Cannulated Reamer, Ø10mm	1
7-014-30	Femoral Cannulated Reamer, Ø11mm	1
7-014-32	Femoral Cannulated Reamer, Ø12mm	1
7-014-33	Drill Guide Handle	1
7-014-99	ACL Elbow Aimer	1
7-014-39	2.4mm Drill Guide Bullet	1
7-014-40	PCL Tibial Aimer	1
7-014-41	PCL Femoral Aimer	1
7-014-43	Nitinol Guide Wire Ø1.2mm x Length 300mm (For Interference Screws)	1
7-014-44	Depth Gauge For Knee ACL/PCL Instrument	1
7-014-49	Tendon Stripper (Closed End), Ø7mm	1
7-014-51	Tendon Stripper (Open End), Ø6mm	1
7-014-54	Graft Sizer, 6mm to 12mm (0.5mm steps)	1
7-014-55	Quick Coupling T-Handle For Tunnel Dilator	1
7-014-57	Tunnel Dilator, Cannulated, Ø7mm	1
7-014-58	Tunnel Dilator, Cannulated, Ø8mm	1
7-014-59	Tunnel Dilator, Cannulated, Ø9mm	1
7-014-61	Straight Rasp	1
7-014-62	Convex Rasp	1
7-014-64	Curette, 25° Angled Down	1
7-014-65	Arthroscopic Probe - Knee	1
7-014-66	Pin, Trocar-Tip, Ø2.4mm x 355mm	1
7-014-67	Pin, Drill Tip, Ø2.4mm x 355mm	1
7-014-68	Passing Pin, Ø2.4mm x 250mm	1
7-014-70	Micro Fracture Awl, 25°	1
7-014-72	Micro Fracture Awl, 60°	1

Code	Set Consisting of	Unit
7-014-73	Tunnel Plug, 7-8mm	1
7-014-74	Tunnel Plug, 8-9mm	1
7-014-75	Tunnel Plug, 9-10mm	1
7-014-76	Staple Impactor	1
7-014-77	PCL Elevator With Wire Capture Hole	1
7-017-01	Graft Station Board	1
7-017-02	Sliding base	1
7-017-03	Graft Grasper Clamp - Left	1
7-017-04	Graft Grasper Clamp - Right	1
7-017-05	Button Holder With Scale	1
7-017-06	Suture Holder With Tensioner	1
7-014-79C	Instrument Tray A for Knee Arthroscopy Instrument Set (Compact)	1
7-014-80C	Instrument Tray B for Knee Arthroscopy Instrument Set (Compact)	1
7-014-81C	Container For Knee Arthroscopy Instrument Set (Compact)	1
7-014-82C	Lid For Container, Knee Arthroscopy Instrument Set (Compact)	1

7-014-79C
Instrument Tray A for Knee Arthroscopy Instrument Set (Compact)

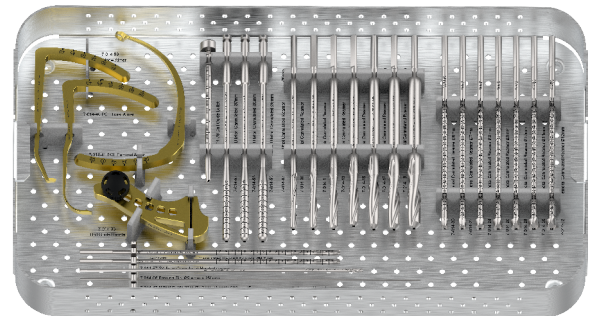

7-014-80C
Instrument Tray B for Knee Arthroscopy Instrument Set (Compact)



7-014-81C
Container For Knee Arthroscopy Instrument Set (Compact)

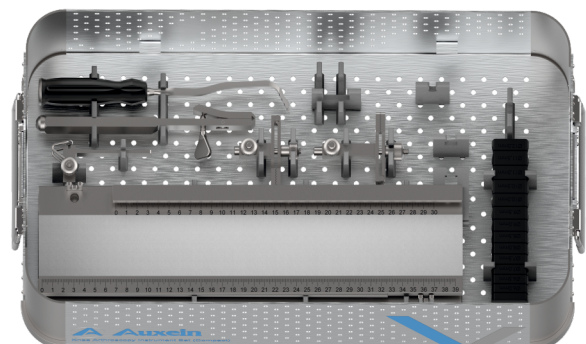

7-014-82C
Lid For Container, Knee Arthroscopy Instrument Set (Compact)

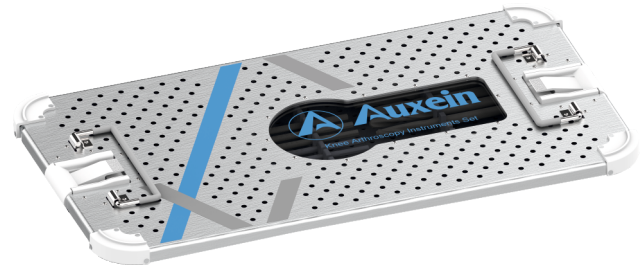

7-017 Graft Station Arthroscopy Instrument Set

Code	Set Consisting of	Unit
7-017-01	Graft Station Board	1
7-017-02	Sliding base	1
7-017-03	Graft Grasper Clamp - Left	1
7-017-04	Graft Grasper Clamp - Right	1
7-017-05	Button Holder With Scale	1
7-017-06	Suture Holder With Tensioner	1
7-014-54	Graft Sizer, 6mm to 12mm (0.5mm steps)	1
7-017-07	Container For Graft Station Instrument Set	1
7-017-08	Lid for Container, Graft Station Instrument Set	1

7-017-07
Container For Graft Station Instrument Set

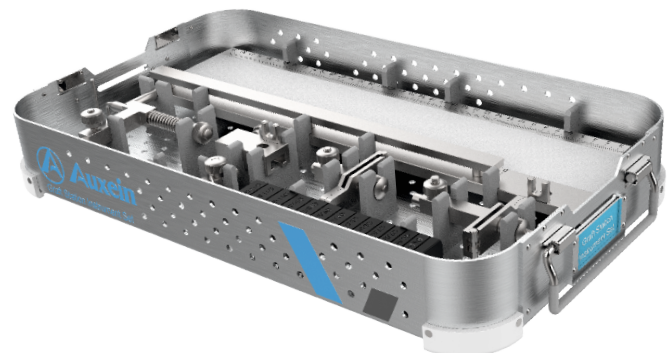

7-017-08
Lid for Container, Graft Station Instrument Set

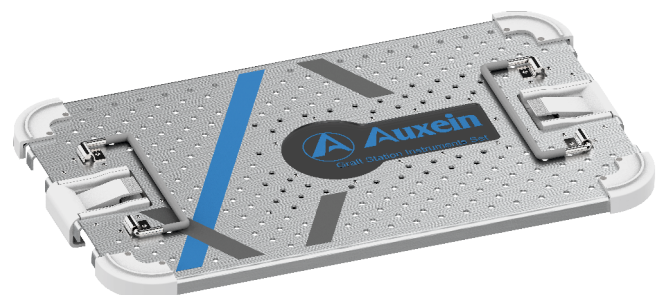

7-156 Instruments Set for MENISCO Inside-Out Meniscal Repair System

Code	Set Consisting of	Unit
7-156-01	Single Lumen Cannula for Meniscal Repair, Straight	1
7-156-02	Single Lumen Cannula for Meniscal Repair, 10° Curve	1
7-156-03	Single Lumen Cannula for Meniscal Repair, 20° Curve	1
7-156-04	Single Lumen Cannula for Meniscal Repair, 30° Curve	1
7-156-05	Single Lumen Cannula for Meniscal Repair, 40° Curve	1
7-156-06	Bender for Cannula	1
7-156-07	Needle Pusher	1
7-156-08	Slotted Cannula	1
7-156-09	Knot Pusher for Meniscal Repair	1
7-156-10	Curved Probe for Meniscal Repair	1
7-156-11	Diamond Rasp, 45° for Meniscal Repair	1
7-156-12	Diamond Rasp, 90° for Meniscal Repair	1
7-156-13	Ring Curette for Meniscal Repair	1
7-156-15	Container for Meniscal Repair Instrument Set	1
7-156-16	Lid for container, Meniscal Repair Instrument Set	1

7-156-15
Container for Meniscal Repair Instrument Set

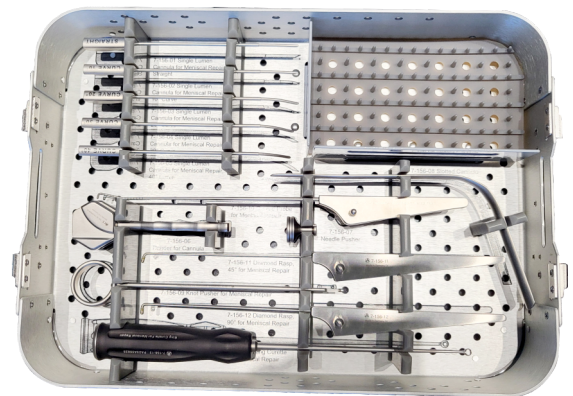

7-156-16
Lid for container, Meniscal Repair Instrument Set

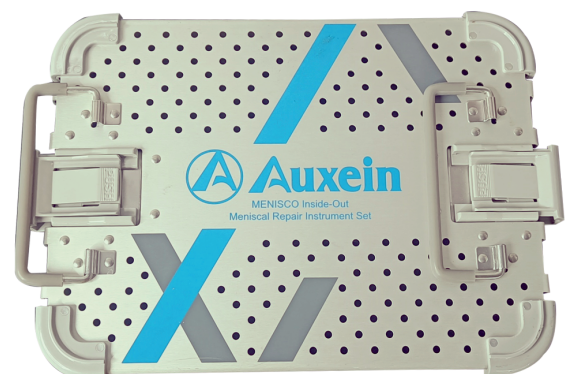

7-148 Retro Drill Guide System

Code	Set Consisting of	Unit
7-148-01	Retro Drill Guide Handle, Side Release	1
7-148-02	2.4mm Retro Guide Pin Sleeve	1
7-148-03	4.5mm Retro Drill Sleeve For FlyKuter	1
7-148-04	Retro Femoral ACL Guide, Right	1
7-148-05	Retro Femoral ACL Guide, Left	1
7-148-06	Retro Tibial ACL Marking Hook	1
7-148-07	Retro PCL Tibial Guide With O Tip	1
7-148-08	Retro PCL Tibial Guide With C Tip	1
7-148-09	Retro PCL Femoral Guide	1
7-148-10	Meniscus Root Marking Hook	1
7-148-11	3.5mm Retro Drill Sleeve For FlyKuter	1
7-148-12	Container for Retro Drill Guide System	1
7-148-13	Lid for Retro Drill Guide System	1

7-148-12
Container for Retro Drill Guide System



7-148-13
Lid for Retro Drill Guide System

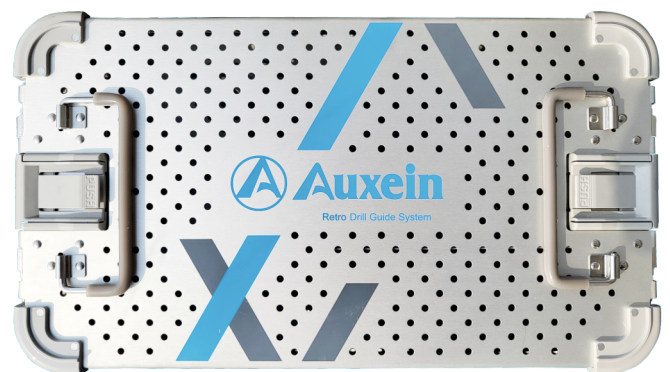



USA

Auxein Inc.

1500 Nw 89th Court, Suite 107-108
Doral, Florida 33172
Tel: +1 305 395 6062
E Fax: +1 305 395 6262
Email: USoffice@auxein.com

MEXICO

Auxein México, S.A. de C.V.

Tepic 139 int 801, Colonia Roma Sur,
Alcaldía Cuauhtémoc, CDMX,
México, C.P. 06760
Tel: +521 55 7261 0318
Email: info@auxein.mx

INDIA

Auxein Medical Pvt. Ltd.

Plot No. 168-169-170, Phase-4,
Kundli Industrial Area,
HSIIDC, Sector-57, Sonapat - 131028, Haryana
Tel: +91 99106 43638 | Fax: +91 86077 70197
Email: info@auxein.com

www.auxein.com